

LUMIBRICKS™

—
12014
500PCS
16+



Scan the QR code
for a PDF instruction



扫码关注公众号
获取电子版说明书

ABOUT LUMIBRICKS

Welcome to Lumibricks, where imagination meets illumination in the brick world!

Formerly known as FUNWHOLE, the world's first lighting bricks manufacturer, Lumibricks continues its legacy as a trailblazer in the world of building brick sets with a unique twist - integrated lighting that transforms every creation into a radiant masterpiece.

Every Lumibricks' set celebrates the joy of building and the magic of illumination. Whether you're crafting intricate architectures or imaginative scenes, the design details and lighting features bring the sets to life, and also bring you joy and shine whether it is the day or night.

At Lumibricks, we believe in the power of light to transform and elevate. With our slogan, "Delight day and night," we invite you to explore the possibilities of illuminated brick sets. Discover a hobby that doesn't just shine - it glows with your inner creativity.

欢迎来到Lumibricks灯搭的乐园

在这里, 我们不仅仅是玩具制造商, 我们还是创造快乐的艺术家。

自2014年诞生起, Lumibricks灯搭(原FUNWHOLE)就坚守一个独特的愿景: 在日与夜的交替中, 为我们的玩家揭示积木之美的无限可能。

作为全球领先的灯光积木品牌, 本着充分表现积木套装整体之美的初衷, Lumibricks致力于灯光积木套装产品的开发, 将积木与灯光合为一体。

Lumibricks不仅仅是一套普通的积木, 更是代表了一种全新的玩乐方式, 每一块积木, 每一束光线, 都承载着我们带给全球数百万家庭更多欢笑的承诺。

我们相信, 积木有灯, 生活有光, 让Lumibricks与你一起, 拼搭出更多乐趣, 创造属于你的灯光宇宙。



开合雨棚/Foldable Awning

药锅/Cauldron

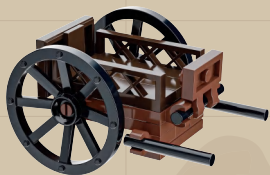

手推车/Pushcart



草药架/Herb Rack



中世纪系列迎来全新的森林阵营组合。

不规则底板可无缝拼接，构建被时光遗忘的森林要塞。建筑与森林融为一体，带来独特视觉与沉浸体验，您也可将其与中世纪其他积木套装组合，代入更多的阵营体验。

The Medieval Series introduces a new Forest Faction set. Irregular baseplates connect seamlessly to build a forgotten woodland stronghold. Blending architecture with nature, it delivers unique visuals and an immersive experience. You can also combine it with other Medieval sets to expand your faction gameplay.



WHAT'S INCLUDED

Please check and make sure you get all the items listed below.



Building Bricks



LED Light Kit



User Manual

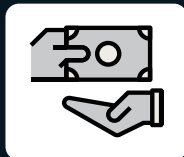

Service Card

TROUBLESHOOTING

The small size of lighting accessories makes them susceptible to damage during installation, and the following issues are common causes of failure.

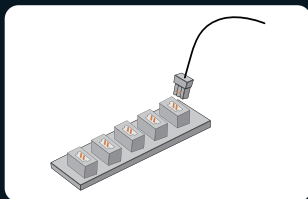

1.Ensure that the connectors are correctly installed as shown in the picture.

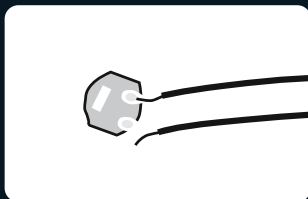

2.Check if the wires are disconnected or broken from the solder joints.

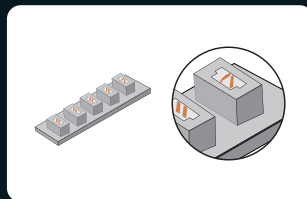

3.Check the internal pins of the connector sockets. The internal pins of a properly working connector port should be straight. If the small pins are bent, they may be considered faulty parts.



4.Check that the power switch on the battery box is on and that the "+" and "-" poles of the battery (using new batteries) and ensure that the upper and lower connections to the "+" and "-" poles of the power switch are installed correctly.

If you have checked each string of lights according to the guide above and the lights still do not light up, please contact our customer service for assistance.

⚠ WARNING:--Do not mix old and new batteries.--Do not mix alkaline, standard(carbon-zinc),or rechargeable batteries.

SAFETY PRECAUTIONS

1. Before use, please make sure to check the voltage to avoid damage to the product and potential safety hazards.
2. The lights in the product are not replaceable. If they are damaged or not lighting up, please refer to the troubleshooting section or contact our customer service for assistance.
3. Avoid pulling on the light connection wires as this may cause damage.
4. Do not expose the product to water as it may damage the product.
5. Please read and follow the instructions carefully during building to ensure a good building experience.
6. This product doesn't include batteries or power banks. Please prepare your own batteries or power banks to power the LED light kits.
7. While there are several models available, the operating procedures and mechanism for Lumibricks expansion boards and battery boxes remain consistent. For inquiries, we encourage you to reach out to our customer service team for assistance.

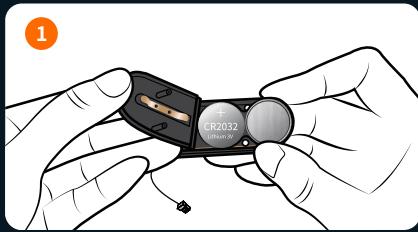

Battery box name: oval battery box

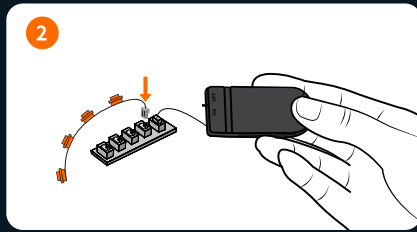

Battery type: CR2032*2

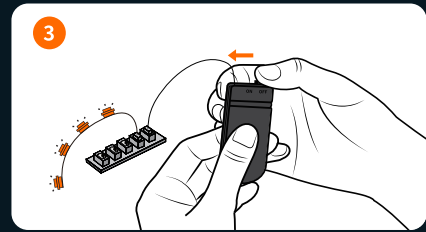

Battery rated voltage: 3V

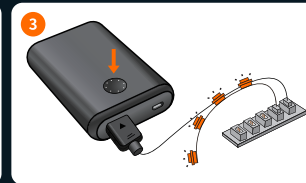
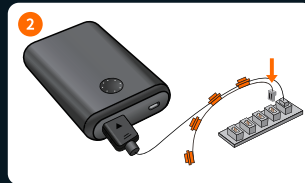
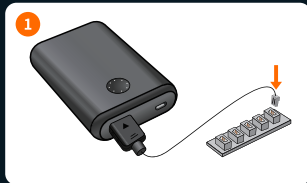

LED LIGHT KIT PACKAGE LIST

Please check and make sure you get all the lighting accessories. Contact us if there are any missing components.

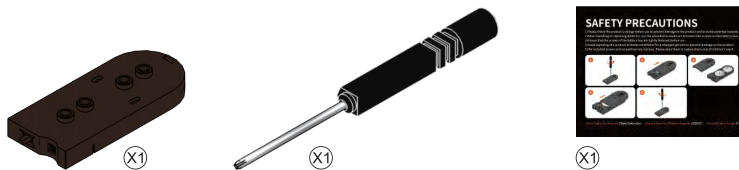
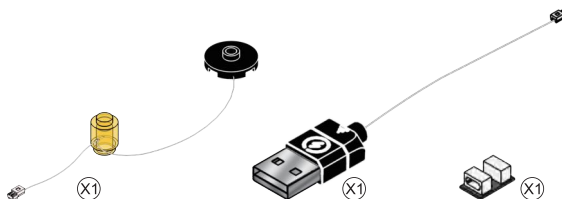

Note: when installing, don't pull it hard, bend it or shake it to avoid damage. Not for children under sixteen.

1. Remove and immediately recycle or dispose of used batteries according to local regulations and keep away from children. Do NOT dispose of batteries in household trash incinerators.
2. Even used batteries may cause severe injury or death.
3. Call a local poison control center for treatment information.
4. Recommended battery type: CR2032*2.
5. Battery voltage: 3V.
6. Non-rechargeable batteries are not to be recharged.
7. Do not force discharge, recharge, disassemble, heat above (manufacturer's specified temperature rating) and incinerate. Doing so may result in injury due to venting, leakage or explosion resulting in chemical burns.
8. Ensure the batteries are installed correctly according to polarity (+ and -).
9. Do not mix old and new batteries, different brands or types of batteries, such as alkaline, carbon-zinc, or rechargeable batteries.
10. Remove and immediately recycle or dispose of batteries from equipment not used for an extended period of time according to local regulations.
11. Always completely secure the battery box. If the battery box does not close securely, stop using the product, remove the batteries, and keep them away from children.

WARNING:

- **INGESTION HAZARD:** This product contains a button cell or coin battery.
- **DEATH** or serious injury can occur if ingested.
- A swallowed button cell or coin battery can cause **Internal Chemical Burns** in as little as **2 hours**.
- **KEEP** new and used batteries **OUT OF REACH of CHILDREN**
- **Seek immediate medical attention** if a battery is suspected to be swallowed or inserted inside any part of the body.



包装配件

请检查包装配件是否完整



积木包



LED灯光配件包



说明书

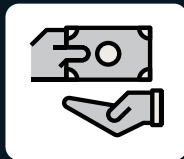

售后卡

灯饰配件故障排除指南

由于灯光配件的尺寸较小,容易因为操作不当而损坏,以下是常见的故障原因

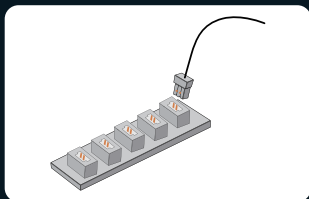

1. 请检查连接器安装正确, 如图所示。

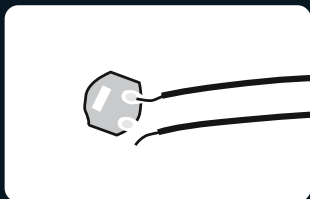

2. 请检查电线是否从焊点脱落或断裂。

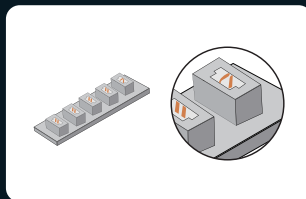

3. 请检查连接器插口的内部引脚, 工作正常的连接器端口内部小引脚应该是直的, 如果是弯的小引脚则可以判断为故障端口。

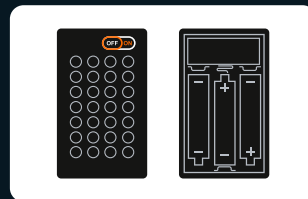

4. 请检查电池盒的电源开关是开启状态并且电池“+”“-”极放置正确 (确保您使用的是新电池。) 请确认上下连接电源开关“+”“-”极, 安装无误。

如以上按照安装指南检查每一串灯, 灯源还是不亮, 请联系我们的客服。

灯饰配件安全使用注意事项:

1. 使用前请确认工作电压, 避免电压损坏产品带来安全隐患;
2. 此灯具光源不可替换, 如损坏不亮请参考故障排查或联系我们的客服;
3. 请勿用力拉扯灯具连接线, 以免损坏产品;
4. 请勿触碰水, 以免损坏产品;
5. 体验安装过程中请仔细阅读并按照说明书进行操作, 以免影响您的体验;
6. 本产品不包括电池或移动电源。请自备电池或电源为LED灯组供电;
7. 扩展板和电池盒存在多种型号, 但使用方法和原理相似。有问题请联系客服。



电池盒名称: 椭圆电池盒

电池型号: CR2032*2

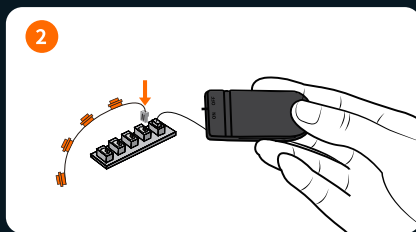

电池额定电压: 3V

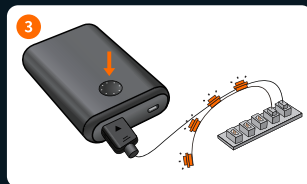
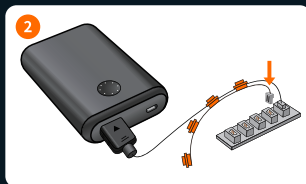
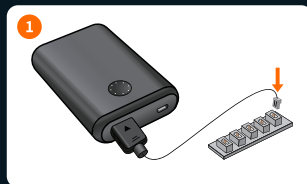
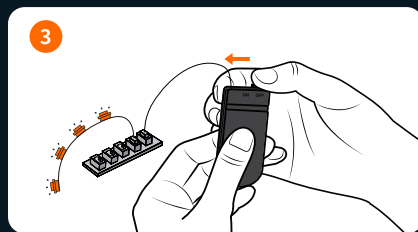

LED灯光配件包清单:

请检查并确保您获得所有照明配件。如果有任何缺少的组件,请联系我们。

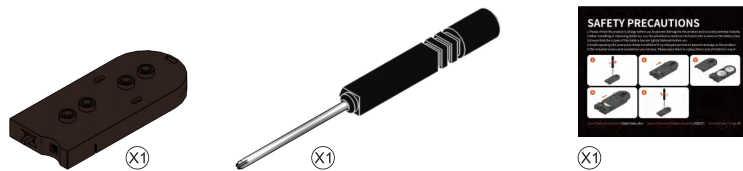
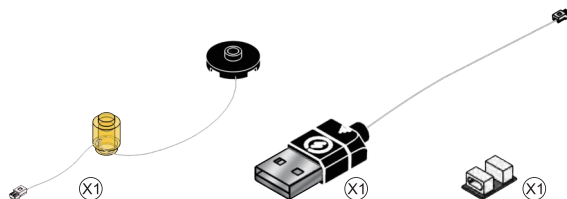

注意: 在安装时, 请不要用力拉扯、弯曲或摇晃它以避免损坏。不适合十六岁以下儿童使用。

1. 请根据当地法规立即移除并回收或处理已使用的电池, 并将其远离儿童。切勿将电池丢弃在家庭垃圾或焚烧炉中。
2. 即使是使用过的电池, 也可能导致严重的伤害或死亡。
3. 请致电当地毒物控制中心获取治疗信息。
4. 推荐的电池类型: CR2032*2。
5. 电池电压: 3V。
6. 不可充电的电池不得进行充电。
7. 请勿强行放电、充电、拆解、加热超过(制造商规定的温度范围)或焚烧。这样做可能会导致因通风、泄漏或爆炸而造成化学烧伤。
8. 请确保电池按照极性(+和-)正确安装。
9. 请勿混合使用旧电池和新电池, 也不要混合不同品牌或类型的电池, 如碱性电池、锌碳电池或可充电电池。
10. 对于长时间未使用的设备, 请立即移除电池并根据当地法规回收或处理。
11. 始终确保电池盒完全固定。如果电池盒无法安全关闭, 请停止使用该产品, 移除电池并将其远离儿童。

WARNING:

- **INGESTION HAZARD:** This product contains a button cell or coin battery.
- **DEATH** or serious injury can occur if ingested.
- A swallowed button cell or coin battery can cause **Internal Chemical Burns** in as little as **2 hours**.
- **KEEP** new and used batteries **OUT OF REACH of CHILDREN**
- **Seek immediate medical attention** if a battery is suspected to be swallowed or inserted inside any part of the body.



WAS IM LIEFERUMFANG ENTHALTEN IST:

Bitte vergewissern Sie sich, dass Sie alle unten aufgeführten Artikel erhalten haben.



Bauklötze



LED-Licht-Kit



Benutzerhandbuch

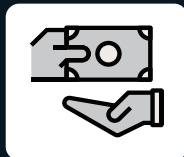

Servicekarte

FEHLERSUCHE

Die geringe Größe des Beleuchtungszubehörs macht es anfällig für Beschädigungen während der Installation. Die folgenden Probleme sind häufige Fehlerursachen.

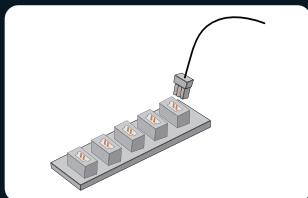

1. Vergewissern Sie sich, dass die Anschlüsse, wie in der Abbildung gezeigt, korrekt installiert sind.

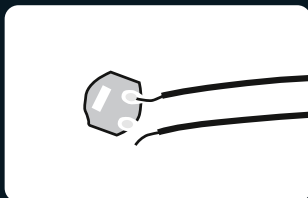

2. Prüfen Sie, ob sich die Drähte von den Lötstellen gelöst haben oder gebrochen sind.

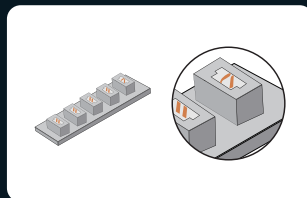

3. Überprüfen Sie die inneren Stifte der Steckerbuchsen. Die inneren Stifte eines ordnungsgemäß funktionierenden Anschlusses sollten gerade sein. Wenn die kleinen Stifte verbogen sind, können sie als fehlerhafte Anschlüsse betrachtet werden.

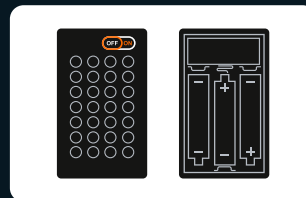

4. Prüfen Sie, ob der Netzschalter am Batteriekasten eingeschaltet ist und ob die Pole „+“ und „-“ der Batterie korrekt platziert sind (bei Verwendung neuer Batterien). Stellen Sie sicher, dass die oberen und unteren Anschlüsse an den Polen „+“ und „-“ des Netzschalters richtig installiert sind.

Wenn Sie die einzelnen Lichterketten gemäß der obigen Anleitung überprüft haben und die Lichter immer noch nicht leuchten, wenden Sie sich bitte an unseren Kundendienst, um Hilfe zu erhalten.

SICHERHEITSVORKEHRUNGEN

1. Prüfen Sie vor der Verwendung die Spannung, um Schäden am Produkt und mögliche Sicherheitsrisiken zu vermeiden.
2. Die Lichter in diesem Produkt sind nicht austauschbar. Wenn sie beschädigt sind oder nicht leuchten, lesen Sie bitte den Abschnitt Fehlerbehebung oder wenden Sie sich an unseren Kundendienst.
3. Ziehen Sie nicht an den Anschlussdrähten der Lampen, um Beschädigungen zu vermeiden.
4. Setzen Sie das Produkt nicht Wasser aus, da es dadurch beschädigt werden kann.
5. Lesen und befolgen Sie die Anweisungen sorgfältig während des Aufbaus, um eine optimale Bauerfahrung zu gewährleisten.
6. Dieses Produkt enthält keine Batterien oder Akkus. Bitte bereiten Sie Ihre eigenen Batterien oder Powerbanks vor, um das LED-Licht-Kit zu betreiben.
7. Obwohl es verschiedene Modelle gibt, bleiben die Betriebsverfahren und der Mechanismus für Lumibricks-Erweiterungsplatinen und Batteriekästen gleich. Bei Fragen wenden Sie sich bitte an unseren Kundendienst.

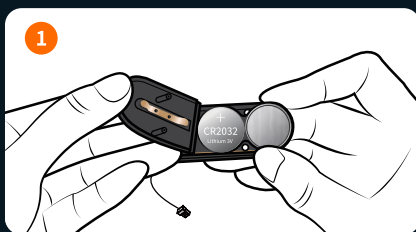

Batteriefachname: Ovale Batteriefach

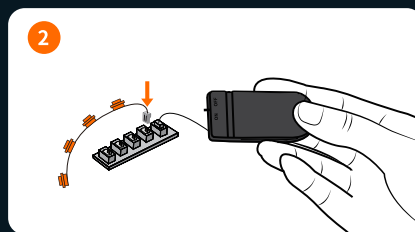

Batteriemodell: CR2032*2

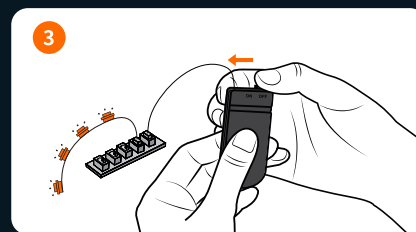

Batterienennspannung: 3V

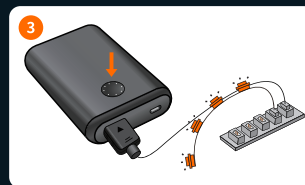
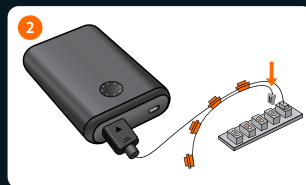
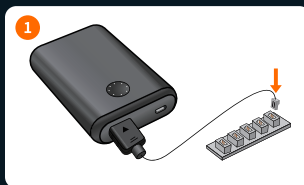

LED LIGHT KIT – PAKETLISTE

Bitte überprüfen Sie, ob Sie das gesamte Beleuchtungszubehör erhalten haben. Kontaktieren Sie uns, falls Komponenten fehlen sollten.

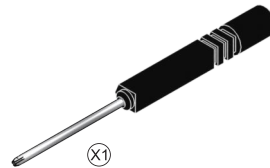
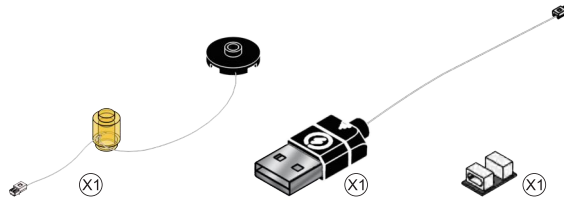

Hinweis: Beim Installieren nicht stark ziehen, biegen oder schütteln, um Schäden zu vermeiden. Nicht für Kinder unter acht Jahren geeignet.

1. Entfernen Sie die verwendeten Batterien und recyceln oder entsorgen Sie sie sofort gemäß den örtlichen Vorschriften. Halten Sie sie von Kindern fern. Entsorgen Sie Batterien NICHT im Haushaltsmüll oder in Müllverbrennungsanlagen.
2. Selbst gebrauchte Batterien können schwere Verletzungen oder den Tod verursachen.
3. Rufen Sie ein örtliches Giftinformationszentrum für Behandlungsinformationen an.
4. Empfohlener Batterietyp: CR2032*2.
5. Batteriewirkung: 3V.
6. Nicht wiederaufladbare Batterien dürfen nicht wiederaufgeladen werden.
7. Entladen, Aufladen, Zerlegen, Überhitzen (über die vom Hersteller angegebene Temperaturgrenze) oder Verbrennen ist nicht erlaubt. Dies kann zu Verletzungen durch Entlüftung, Auslaufen oder Explosionen führen, die zu chemischen Verbrennungen führen können.
8. Stellen Sie sicher, dass die Batterien gemäß der Polarität (+ und -) korrekt installiert sind.
9. Mischen Sie keine alten und neuen Batterien, verschiedene Marken oder Typen von Batterien, wie z. B. Alkaline-Batterien, Zink-Kohlenstoff-Batterien oder wiederaufladbare Batterien.
10. Entfernen Sie die Batterien und recyceln oder entsorgen Sie sie sofort gemäß den örtlichen Vorschriften aus Geräten, die längere Zeit nicht verwendet wurden.
11. Stellen Sie sicher, dass der Batteriefachdeckel immer vollständig verschlossen ist. Wenn der Deckel nicht sicher schließt, stellen Sie die Verwendung des Produkts ein, entfernen Sie die Batterien und halten Sie sie von Kindern fern.

WARNING:

- **INGESTION HAZARD:** This product contains a button cell or coin battery.
- **DEATH** or serious injury can occur if ingested.
- A swallowed button cell or coin battery can cause **Internal Chemical Burns** in as little as **2 hours**.
- **KEEP** new and used batteries **OUT OF REACH of CHILDREN**
- **Seek immediate medical attention** if a battery is suspected to be swallowed or inserted inside any part of the body.



CE QUI EST INCLUS :

Veillez vérifier et vous assurer que vous avez bien reçu tous les articles mentionnés ci-dessous.



Briques de construction



Kit d'éclairage LED



Manuel d'utilisation

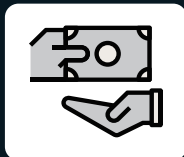

Carte de service

LE DÉPANNAGE

La petite taille des accessoires d'éclairage les rend susceptibles d'être endommagés lors de l'installation. Les problèmes suivants sont des causes fréquentes de défaillance.

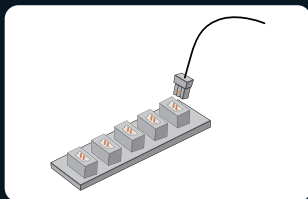

1. Assurez-vous que les connecteurs sont correctement installés comme indiqué sur l'image.

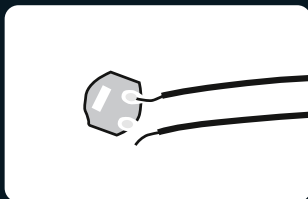

2.Vérifiez que les fils ne sont pas déconnectés ou cassés au niveau des joints de soudure.

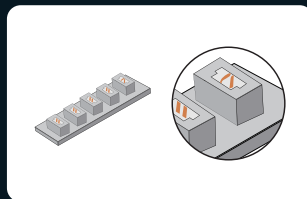

3.Vérifiez les broches internes des connecteurs. Les broches internes d'un port de connecteur fonctionnant correctement doivent être droites. Si les petites broches sont pliéés, elles peuvent être considérées comme des ports défectueux.

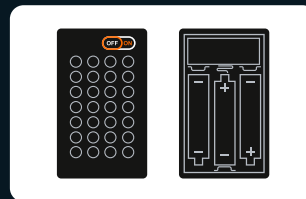

4.Vérifiez que l'interrupteur du boîtier de la batterie est en position de marche et que les pôles « + » et « - » de la batterie sont correctement placés (en utilisant des batteries neuves). Assurez-vous également que les connexions supérieures et inférieures aux pôles « + » et « - » de l'interrupteur sont correctement installées.

Si vous avez vérifié chaque guirlande lumineuse conformément au guide ci-dessus et que les lumières ne s'allument toujours pas, veuillez contacter notre service clientèle pour obtenir de l'aide.

⚠ AVERTISSEMENT :--Ne mélangez pas des piles neuves et des piles usagées.--Ne mélangez pas l'alcalin avec le standard

PRÉCAUTIONS DE SÉCURITÉ

1. Avant toute utilisation, veuillez à vérifier la tension pour éviter d'endommager le produit et prévenir tout risque de sécurité.
2. Les lampes du produit ne sont pas remplaçables. Si elles sont endommagées ou ne s'allument pas, veuillez consulter la section de dépannage ou contacter notre service clientèle pour assistance.
3. Évitez de tirer sur les fils de connexion des lampes, car cela pourrait les endommager.
4. N'exposez pas le produit à l'eau, car cela pourrait l'endommager.
5. Veuillez lire et suivre attentivement les instructions lors de la construction pour garantir une expérience optimale.
6. Ce produit ne comprend pas de piles ni de banques d'alimentation. Veuillez préparer vos propres piles ou banques d'alimentation pour alimenter les kits de lumières LED.
7. Bien qu'il existe plusieurs modèles, les procédures de fonctionnement et le mécanisme des cartes d'extension Lumibricks et des boîtiers de piles restent cohérents. Si vous avez des questions, veuillez contacter notre service clientèle.

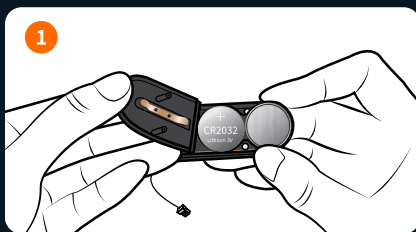

Nom du boîtier à piles: Boîtier de batterie ovale

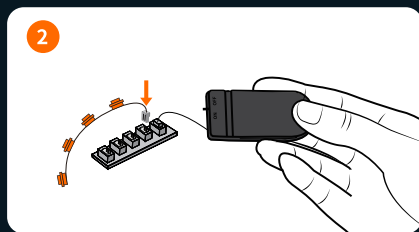

Type de piles: CR2032*2

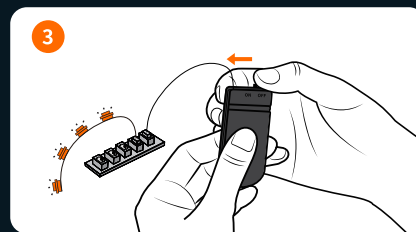

Tension nominale de la pile: 3V

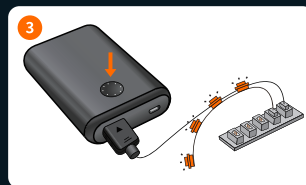
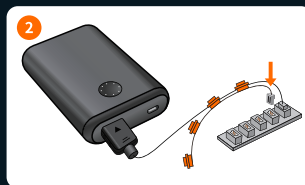
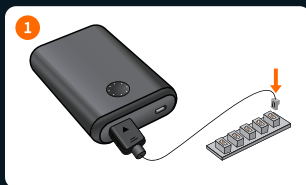

LISTE DE COLISAGE DU KIT D'ÉCLAIRAGE À LEDS

Veillez vérifier et vous assurer que vous avez reçu tous les accessoires d'éclairage. Si des composants sont manquants, veuillez nous contacter.

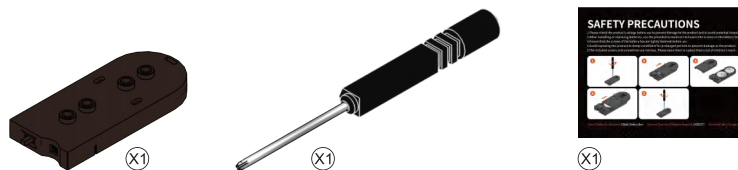
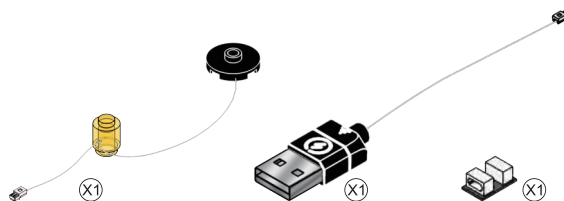

Remarque: lors de l'installation, ne tirez pas fort, ne pliez pas et ne secouez pas pour éviter tout dommage. Ne convient pas aux enfants de moins de huit ans.

1. Retirez immédiatement les piles usagées et recyclez-les ou éliminez-les conformément à la réglementation locale, en les tenant hors de portée des enfants. **NE JETEZ PAS** les piles dans les ordures ménagères ou les incinérateurs.
2. Même les piles usagées peuvent causer des blessures graves ou la mort.
3. Appelez un centre antipoison local pour des informations sur le traitement.
4. Type de pile recommandé : CR2032*2.
5. Tension de la pile : 3V.
6. Les piles non rechargeables ne doivent pas être rechargées.
7. Ne forcez pas la décharge, le rechargement, le démontage, ne chauffez pas au-delà de la température spécifiée par le fabricant et ne les incinérez pas. Cela peut provoquer des blessures dues à des fuites, des explosions ou des brûlures chimiques.
8. Assurez-vous que les piles sont installées correctement selon la polarité (+ et -).
9. Ne mélangez pas des piles anciennes et neuves, ni différentes marques ou types de piles, comme les piles alcalines, carbone-zinc ou rechargeables.
10. Retirez immédiatement les piles et recyclez-les ou éliminez-les conformément à la réglementation locale pour les appareils non utilisés pendant une longue période.
11. Assurez-vous toujours que le boîtier de la pile est complètement sécurisé. Si le boîtier de la pile ne ferme pas correctement, cessez d'utiliser le produit, retirez les piles et tenez-les hors de portée des enfants.

WARNING:

- **INGESTION HAZARD:** This product contains a button cell or coin battery.
- **DEATH** or serious injury can occur if ingested.
- A swallowed button cell or coin battery can cause **Internal Chemical Burns** in as little as **2 hours**.
- **KEEP** new and used batteries **OUT OF REACH of CHILDREN**
- **Seek immediate medical attention** if a battery is suspected to be swallowed or inserted inside any part of the body.



COSA È INCLUSO:

Controllare e assicurarsi di ricevere tutti gli articoli elencati di seguito.



Mattoni da costruzione



Kit di luci a LED



Manuale d'uso

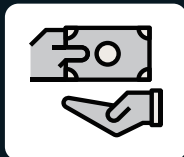

Scheda di servizio

RISOLUZIONE DEI PROBLEMI

Le dimensioni ridotte degli accessori per l'illuminazione li rendono suscettibili di danni durante l'installazione e i seguenti problemi sono cause comuni di guasto.

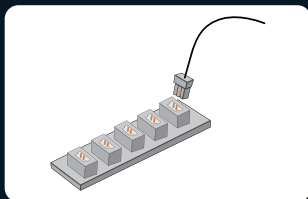

1. Assicurarsi che i connettori siano installati correttamente come mostrato nella figura.

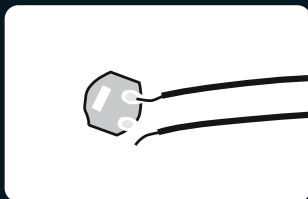

2. Controllare se i fili sono scollegati o rotti dalle saldature.

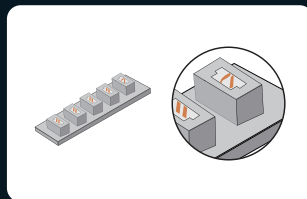

3. Controllare i pin interni delle prese dei connettori. I pin interni di una porta del connettore che funziona correttamente devono essere dritti. Se i piccoli pin sono piegati, possono essere considerati porte difettose.

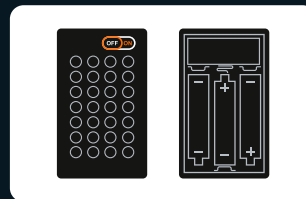

4. Verificare che l'interruttore di alimentazione sulla scatola della batteria sia acceso e che i poli "+" e "-" della batteria siano posizionati correttamente (utilizzando batterie nuove) e assicurarsi che i collegamenti superiori e inferiori ai poli "+" e "-" dell'interruttore di alimentazione siano installati correttamente.

Se avete controllato ogni stringa di luci secondo la guida di cui sopra e le luci non si accendono ancora, contattate il nostro servizio clienti per assistenza.

PRECAUZIONI DI SICUREZZA

1. Prima dell'uso, verificare il voltaggio per evitare danni al prodotto e potenziali rischi per la sicurezza.
2. Le luci del prodotto non sono sostituibili. Se sono danneggiate o non si accendono, consultare la sezione di risoluzione dei problemi o contattare il nostro servizio clienti per assistenza.
3. Evitare di tirare i fili di collegamento delle luci per evitare di danneggiarli.
4. Non esporre il prodotto all'acqua per non danneggiarlo.
5. Leggere e seguire attentamente le istruzioni durante la costruzione per garantire una buona esperienza di costruzione.
6. Questo prodotto non include batterie o power bank. Si prega di preparare le proprie batterie o power bank per alimentare i kit di luci LED.
7. Sebbene siano disponibili diversi modelli, le procedure e i meccanismi di funzionamento delle schede di espansione Lumibricks e delle scatole di batterie rimangono invariati. Per qualsiasi domanda, vi invitiamo a contattare il nostro servizio clienti per ricevere assistenza.

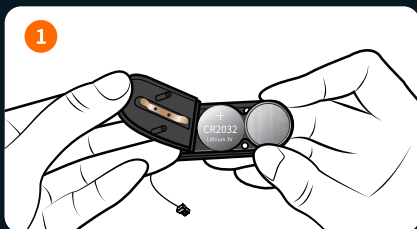

Nome della scatola della batteria: Vano batteria ovale

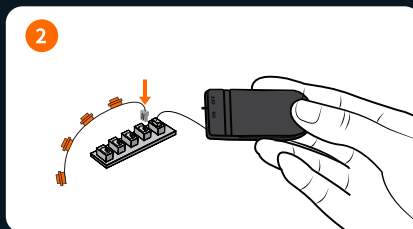

Tipo di batteria: CR2032*2

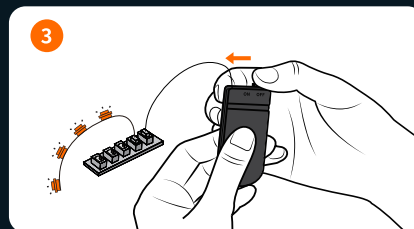

Tensione nominale della batteria: 3V

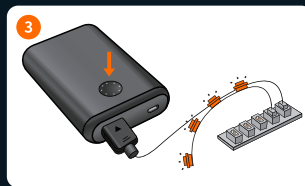
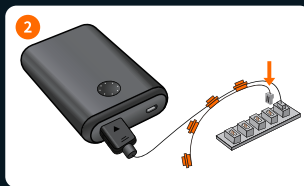
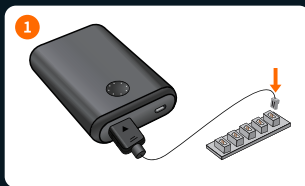

ELENCO DEI PACCHETTI DEL KIT LUCI A LED

Si prega di controllare e assicurarsi di ottenere tutti gli accessori di illuminazione. Contattateci se ci sono componenti mancanti.

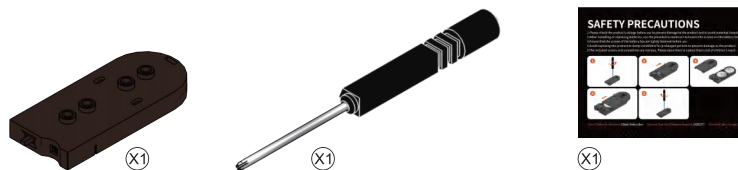
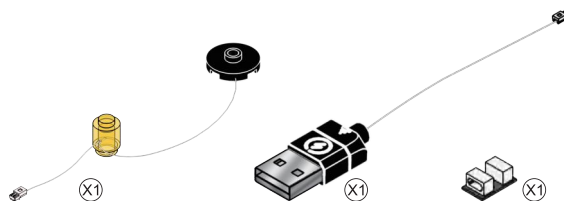

Nota: durante l'installazione, non tirare forte, non piegare e non scuotere per evitare danni. Non adatto a bambini di età inferiore a otto anni.

1. Rimuovere immediatamente le batterie usate e riciclarle o smaltirle secondo le normative locali e tenerle lontano dalla portata dei bambini. NON smaltire le batterie nei rifiuti domestici o negli inceneritori.
2. Anche le batterie usate possono causare gravi lesioni o morte.
3. Contattare un centro antiveleni locale per informazioni sul trattamento.
4. Tipo di batteria raccomandato: CR2032*2.
5. Tensione della batteria: 3V.
6. Le batterie non ricaricabili non devono essere ricaricate.
7. Non forzare la scarica, la ricarica, smontare, riscaldare oltre la temperatura specificata dal produttore e non incenerire. Ciò può provocare lesioni dovute a fuoriuscite, perdite o esplosioni che causano ustioni chimiche.
8. Assicurarsi che le batterie siano installate correttamente in base alla polarità (+ e -).
9. Non mescolare batterie vecchie e nuove, batterie di marche o tipi diversi, come alcaline, zinco-carbonio o batterie ricaricabili.
10. Rimuovere immediatamente le batterie e riciclarle o smaltirle secondo le normative locali da apparecchi non utilizzati per lunghi periodi di tempo.
11. Assicurarsi sempre che il vano batteria sia completamente sicuro. Se il vano batteria non si chiude correttamente, smettere di usare il prodotto, rimuovere le batterie e tenerle lontano dalla portata dei bambini.

⚠ WARNING:

- **INGESTION HAZARD:** This product contains a button cell or coin battery.
- **DEATH** or serious injury can occur if ingested.
- A swallowed button cell or coin battery can cause **Internal Chemical Burns** in as little as **2 hours**.
- **KEEP** new and used batteries **OUT OF REACH of CHILDREN**
- **Seek immediate medical attention** if a battery is suspected to be swallowed or inserted inside any part of the body.



QUÉ SE INCLUYE:

Por favor, compruebe y asegúrese de obtener todos los elementos que se enumeran a continuación.



Ladrillos de construcción



Kit de iluminación LED



Manual del usuario

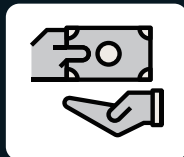

Tarjeta de servicio

SOLUCIÓN DE PROBLEMAS

El pequeño tamaño de los accesorios de iluminación los hace susceptibles de sufrir daños durante la instalación, y los siguientes problemas son causas comunes de avería.

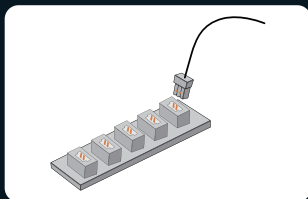

1. Asegúrese de que los conectores están correctamente instalados como se muestra en la imagen.

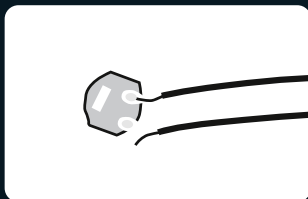

2. Compruebe si los cables están desconectados o rotos de las juntas de soldadura.

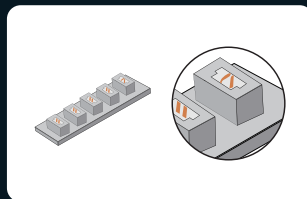

3. Compruebe las patillas internas de las tomas de los conectores. Las patillas internas de una toma de conector que funcione correctamente deben estar rectas. Si las pequeñas patillas están dobladas, pueden considerarse puertos defectuosos.

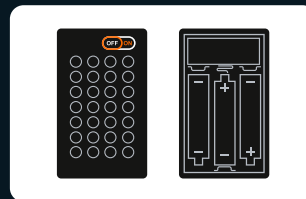

4. Compruebe que el interruptor de alimentación de la caja de la batería está encendido y que los polos «+» y «-» de la batería están colocados correctamente (utilizando baterías nuevas), y asegúrese de que las conexiones superior e inferior a los polos «+» y «-» del interruptor de alimentación están instaladas correctamente.

Si ha comprobado cada cadena de luces según la guía anterior y las luces siguen sin encenderse, póngase en contacto con nuestro servicio de atención al cliente para obtener ayuda.

PRECAUCIONES DE SEGURIDAD

1. Antes de utilizarlo, asegúrese de comprobar el voltaje para evitar daños en el producto y posibles riesgos para la seguridad.
2. Las luces del producto no son reemplazables. Si están dañadas o no se encienden, consulte la sección de solución de problemas o póngase en contacto con nuestro servicio de atención al cliente para obtener ayuda.
3. Evite tirar de los cables de conexión de las luces, ya que podría causar daños.
4. No exponga el producto al agua ya que podría dañarlo.
5. Por favor, lea y siga las instrucciones cuidadosamente durante la construcción para asegurar una buena experiencia de construcción.
6. Este producto no incluye pilas ni baterías. Por favor, prepare sus propias baterías o bancos de energía para alimentar los kits de luces LED.
7. Aunque hay varios modelos disponibles, los procedimientos de funcionamiento y el mecanismo de las tarjetas de expansión Lumibricks y las cajas de baterías siguen siendo los mismos. Para cualquier consulta, le animamos a ponerse en contacto con nuestro equipo de atención al cliente para obtener ayuda.

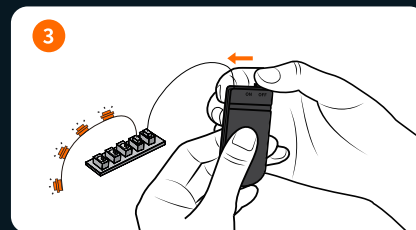
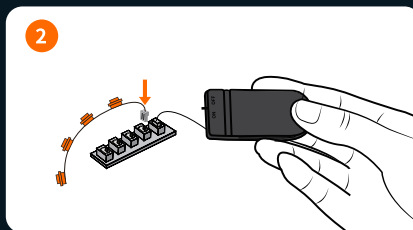
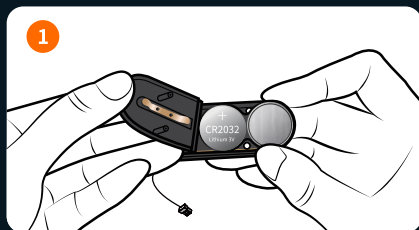

Nombre de la caja de baterías: Caja de baterías ovalada

Tipo de pila: CR2032*2

Voltaje nominal de la pila: 3V

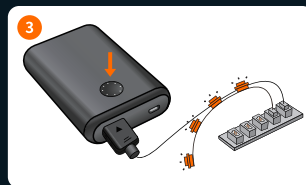
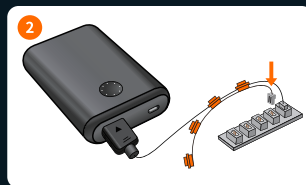
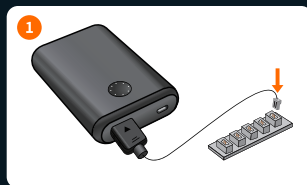

LISTA DE PAQUETES DEL KIT DE ILUMINACIÓN LED

Por favor, compruebe y asegúrese de obtener todos los accesorios de iluminación. Póngase en contacto con nosotros si hay componentes que faltan.

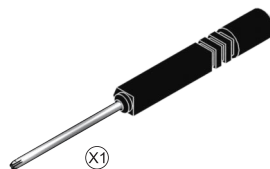
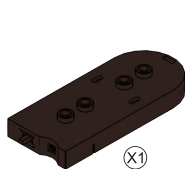

Nota: al instalar, no tire con fuerza, no doble ni agite para evitar daños. No apto para niños menores de ocho años.

1. Retire y recicle inmediatamente las baterías usadas o deséchelas de acuerdo con las regulaciones locales y manténgalas fuera del alcance de los niños. NO deseche las baterías en la basura doméstica o en incineradores.
2. Incluso las baterías usadas pueden causar lesiones graves o la muerte.
3. Llame a un centro local de control de envenenamiento para obtener información sobre el tratamiento.
4. Tipo de batería recomendado: CR2032*2.
5. Voltaje de la batería: 3V.
6. Las baterías no recargables no deben ser recargadas.
7. No fuerce la descarga, recargue, desmonte, calienta por encima de la temperatura especificada por el fabricante ni incinere. Esto puede causar lesiones debido a ventilaciones, fugas o explosiones que resulten en quemaduras químicas.
8. Asegúrese de que las baterías estén instaladas correctamente según la polaridad (+ y -).
9. No mezcle baterías viejas y nuevas, ni baterías de marcas o tipos diferentes, como alcalinas, de carbono-zinc o recargables.
10. Retire inmediatamente las baterías y recíclelas o deséchelas de acuerdo con las regulaciones locales de dispositivos no utilizados durante un período prolongado.
11. Asegúrese de que el compartimento de la batería esté siempre completamente cerrado. Si el compartimento no cierra de forma segura, deje de usar el producto, retire las baterías y manténgalas fuera del alcance de los niños.

⚠ WARNING:

- **INGESTION HAZARD:** This product contains a button cell or coin battery.
- **DEATH** or serious injury can occur if ingested.
- A swallowed button cell or coin battery can cause **Internal Chemical Burns** in as little as **2 hours**.
- **KEEP** new and used batteries **OUT OF REACH of CHILDREN**
- **Seek immediate medical attention** if a battery is suspected to be swallowed or inserted inside any part of the body.



ZH 灯光检查

EN Check Light

FR Contrôle de lumière

DE Lichtcheck

IT Controllo luci

ES Chequeo de luz

1

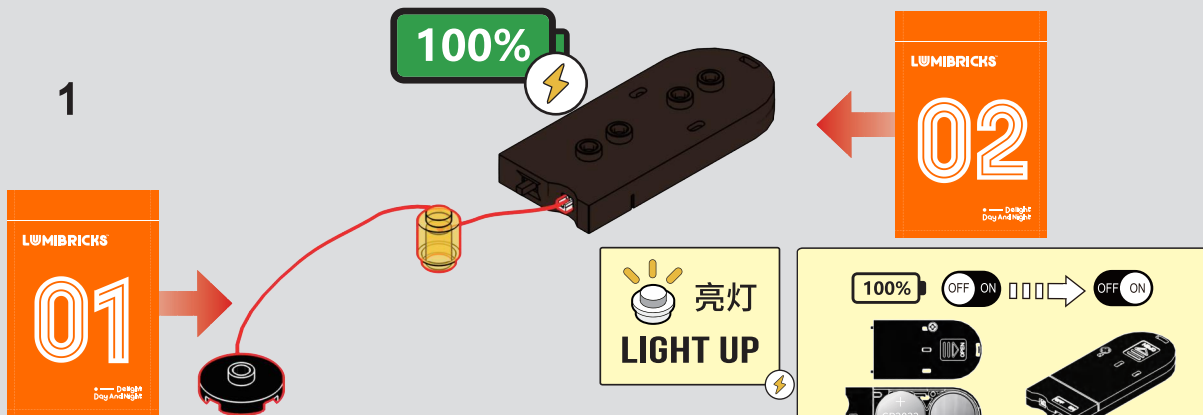

2

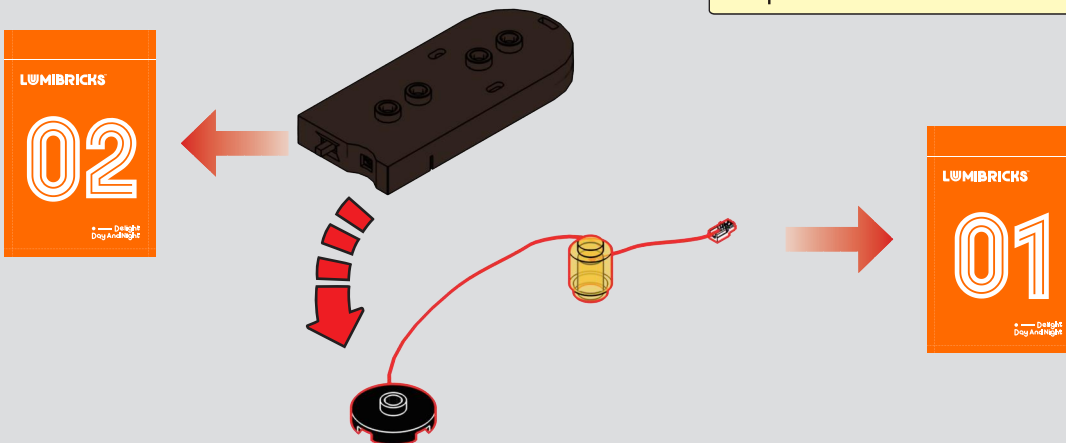



- ZH** F包含有两部分：人仔零件和特殊零件。根据后续的指引组装人仔。将特殊零件保留好，以便后续使用。
- EN** The F-pack contains two parts: minifigure bricks and special bricks. Assemble the minifigure according to the following instructions. Keep the special bricks for later use.
- FR** Le F-pack se compose de deux parties : des briques de minifigurine et des briques spéciales. Assemblez la minifigurine en suivant les instructions ultérieures. Conservez les briques spéciales pour une utilisation future.
- DE** Das F-Pack besteht aus zwei Teilen: Minifiguren-Bausteinen und speziellen Bausteinen. Setzen Sie die Minifigur gemäß den weiteren Anweisungen zusammen. Bewahren Sie die speziellen Bausteine für die spätere Verwendung gut auf.
- IT** Il F-pack è composto da due parti: mattoncini per minifigure e mattoncini speciali. Assembla la minifigure seguendo le istruzioni successive. Conserva i mattoncini speciali per un uso futuro.
- ES** El F-pack tiene dos partes: ladrillos de minifigura y ladrillos especiales. Ensambla la minifigura siguiendo las instrucciones posteriores. Guarda los ladrillos especiales para usarlos más adelante.

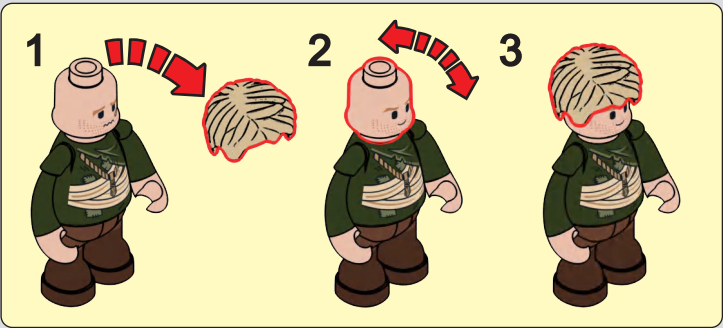
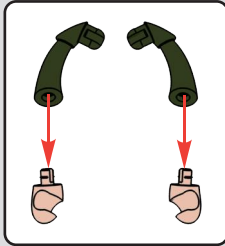
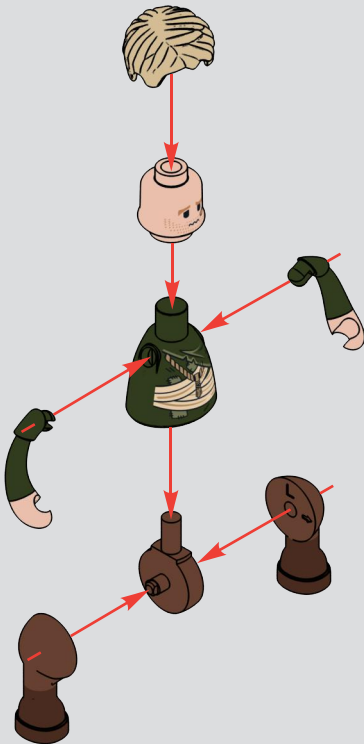
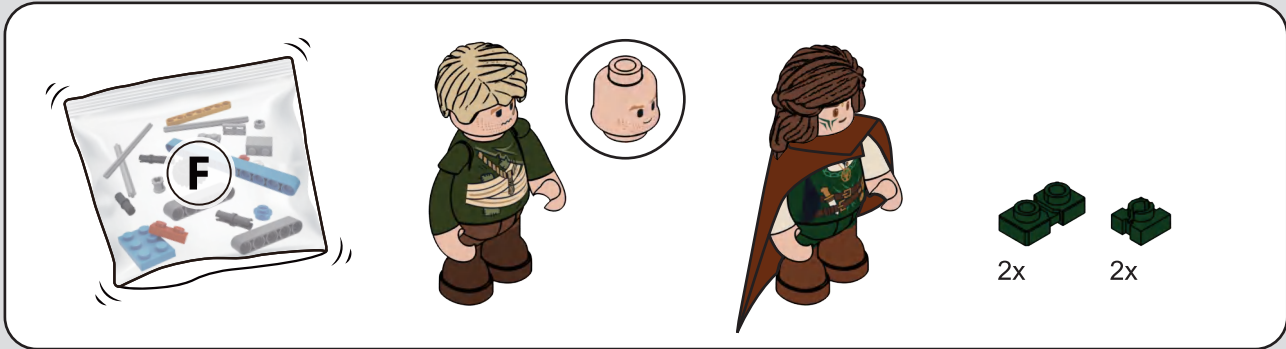

1

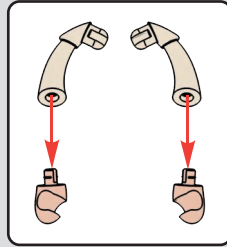
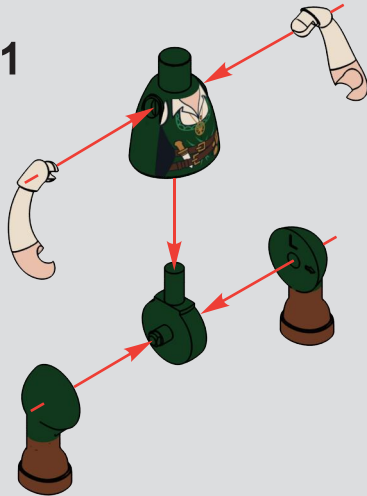

2



3

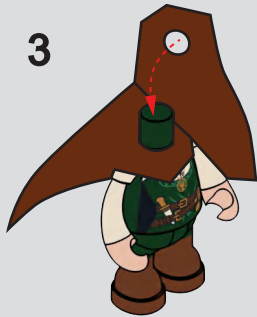

4



5

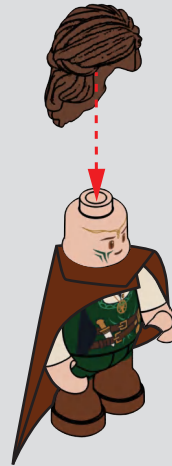

6



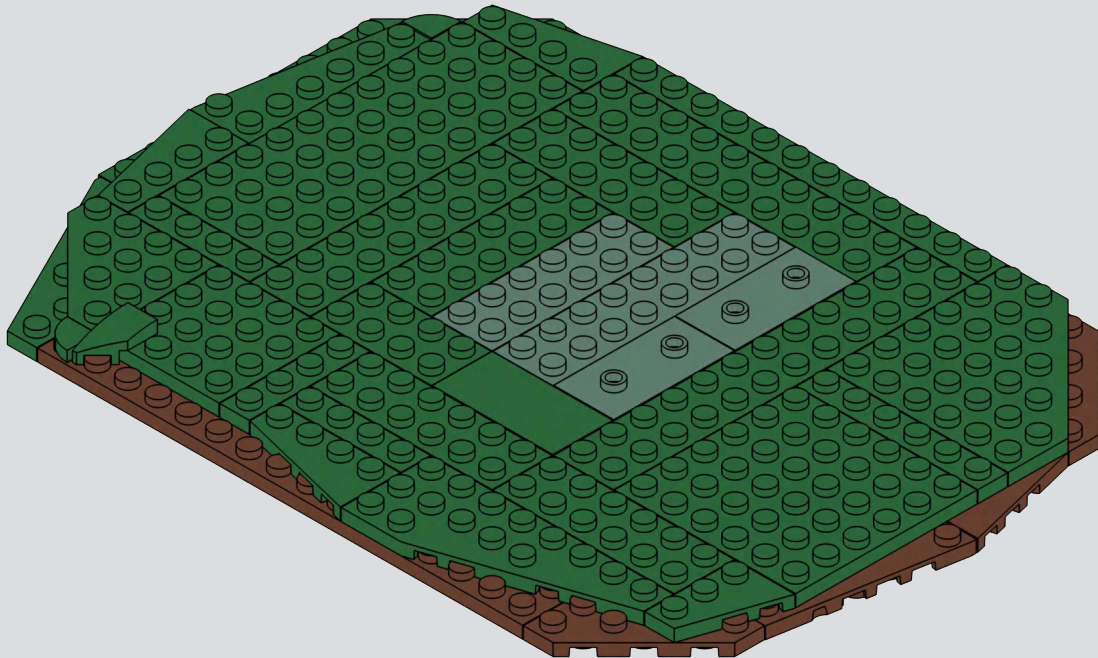

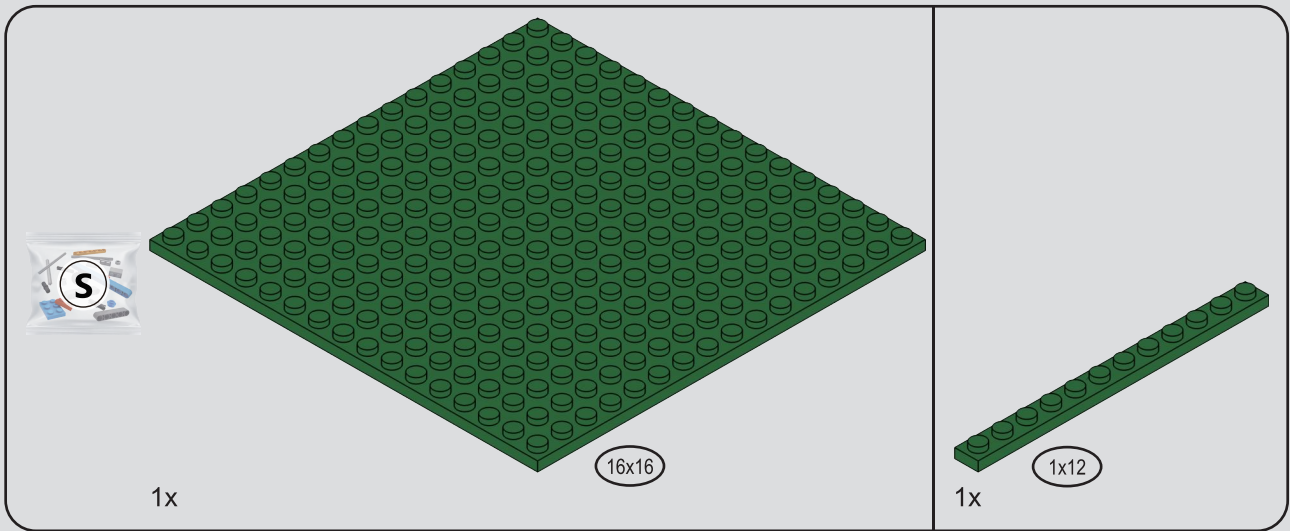

1

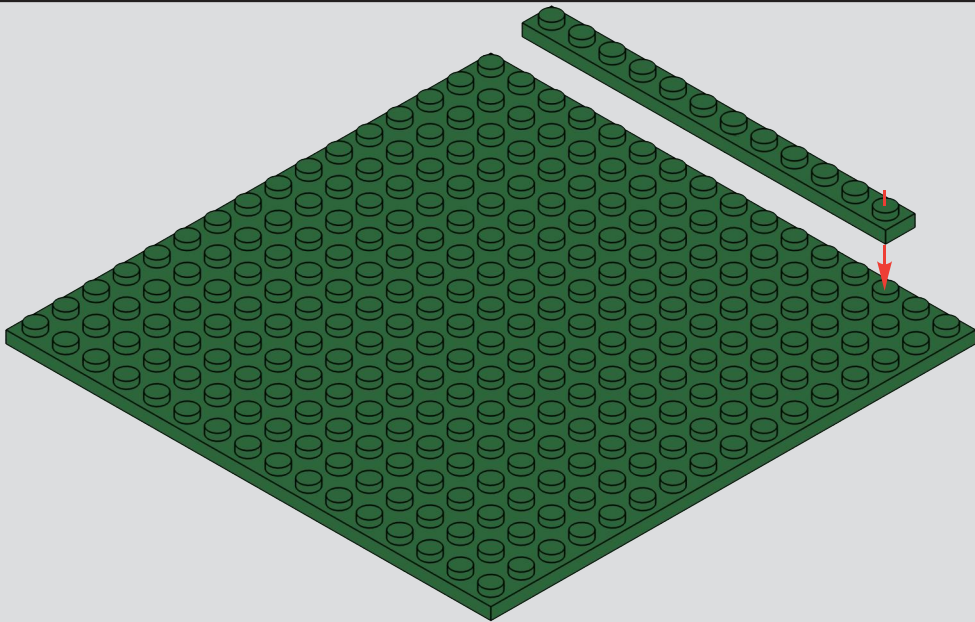

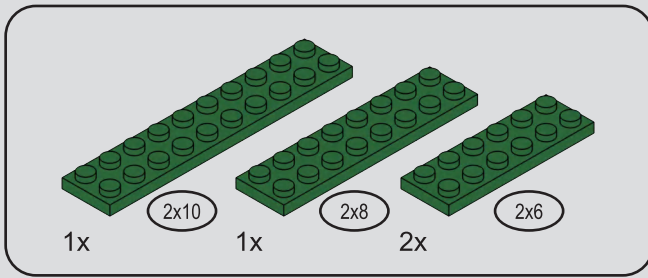

2

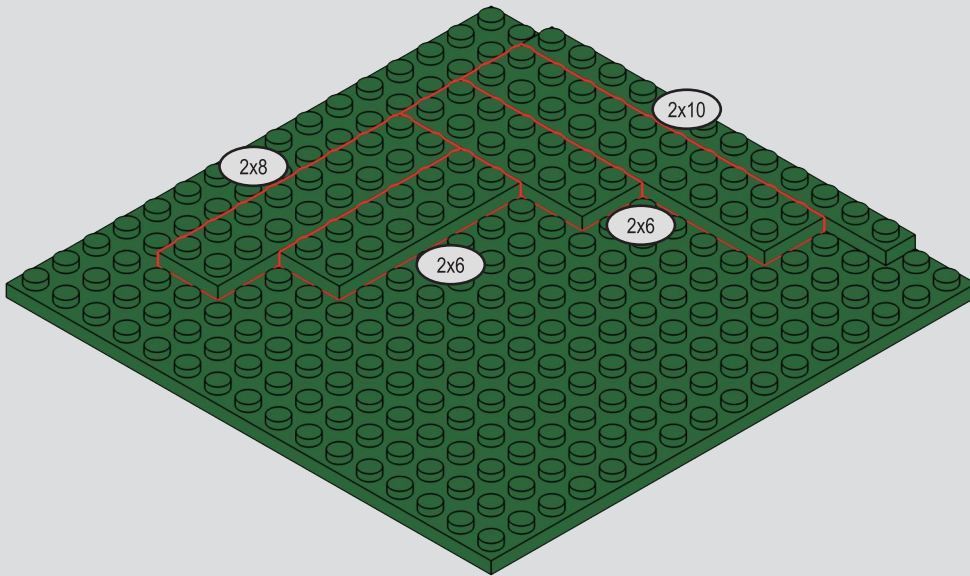

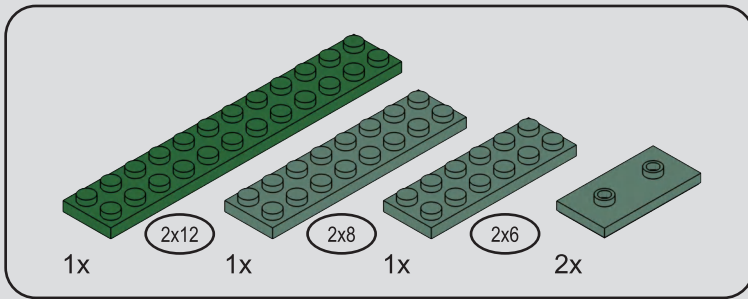

3

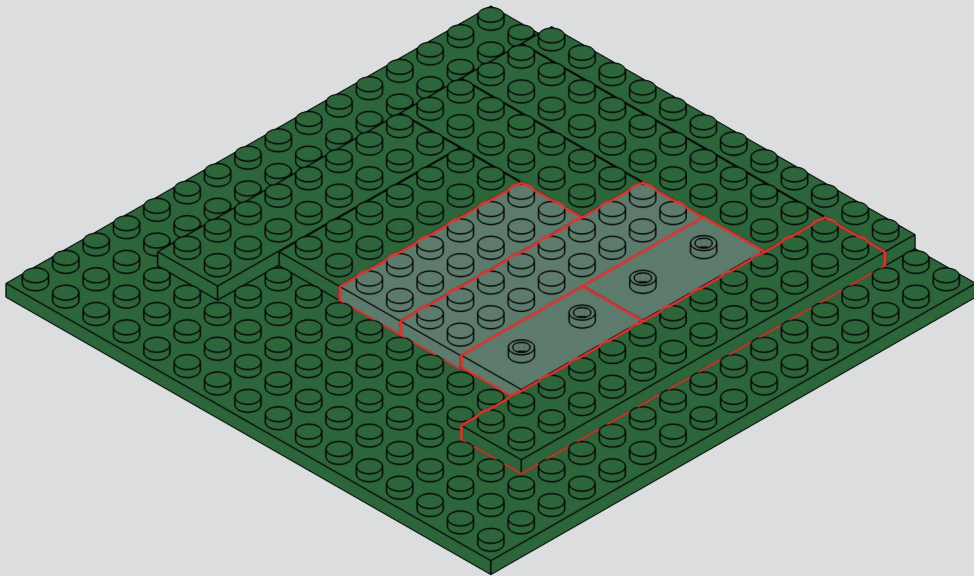

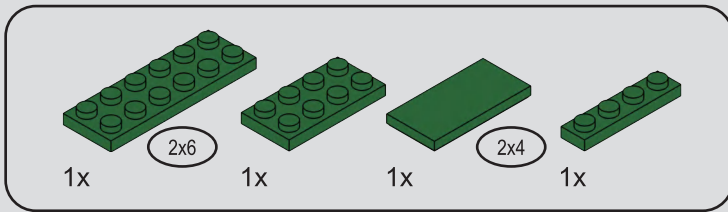

4

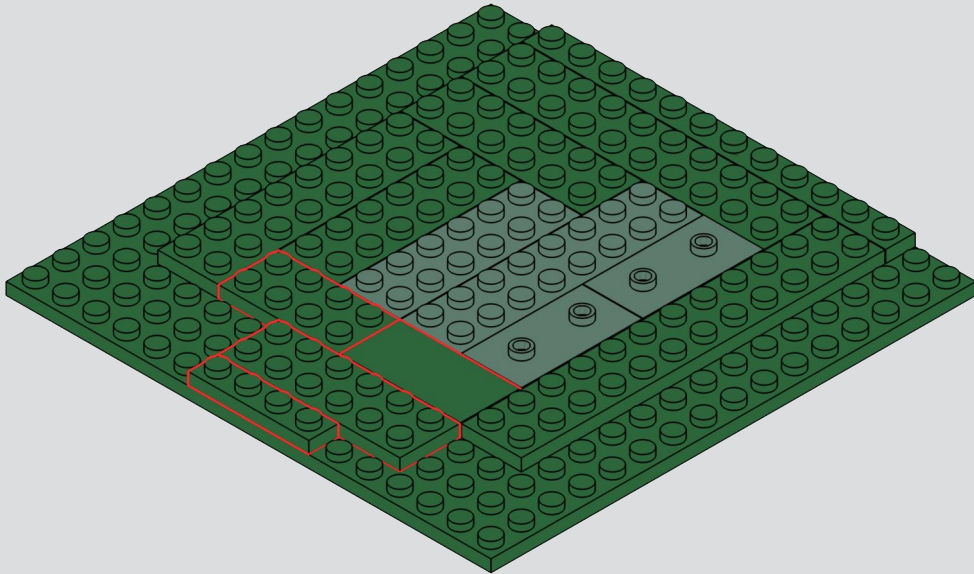

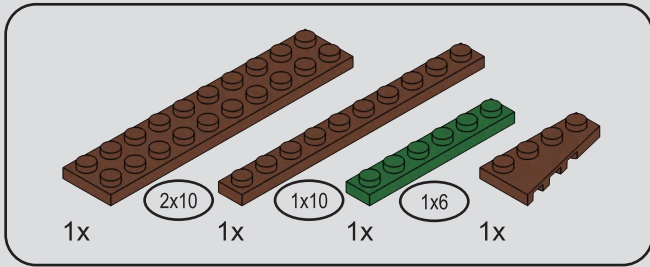

5

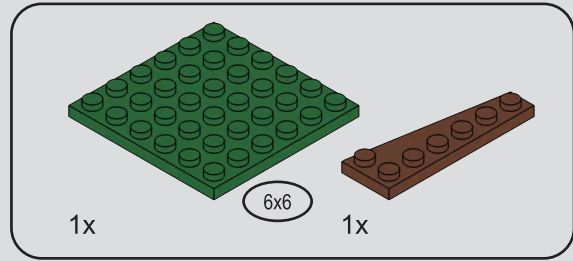
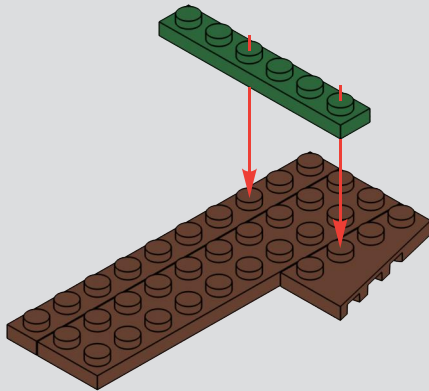

6

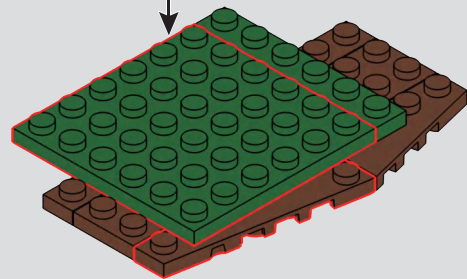
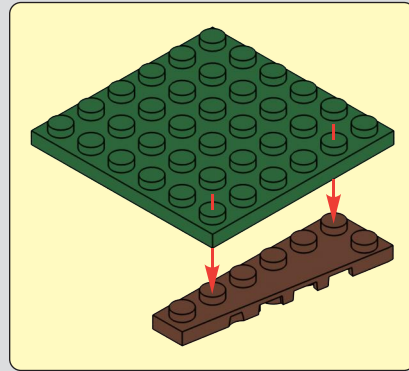

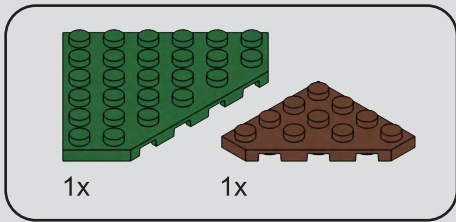

7

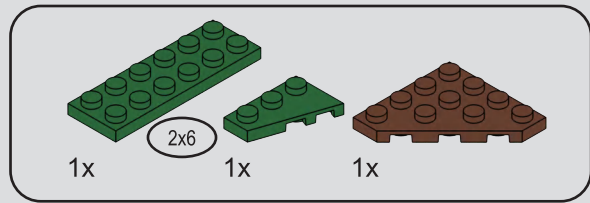
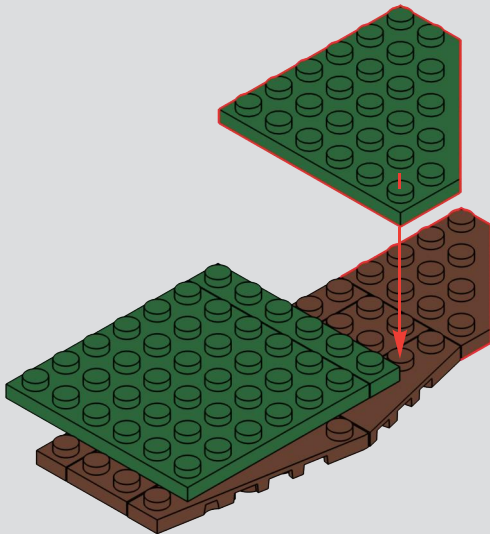

8

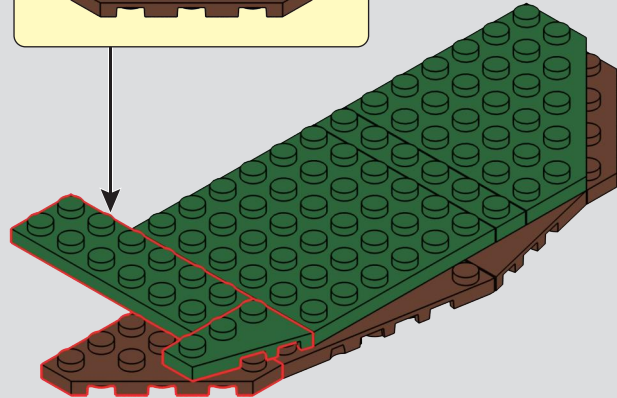
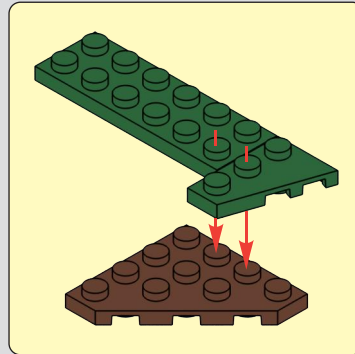

9

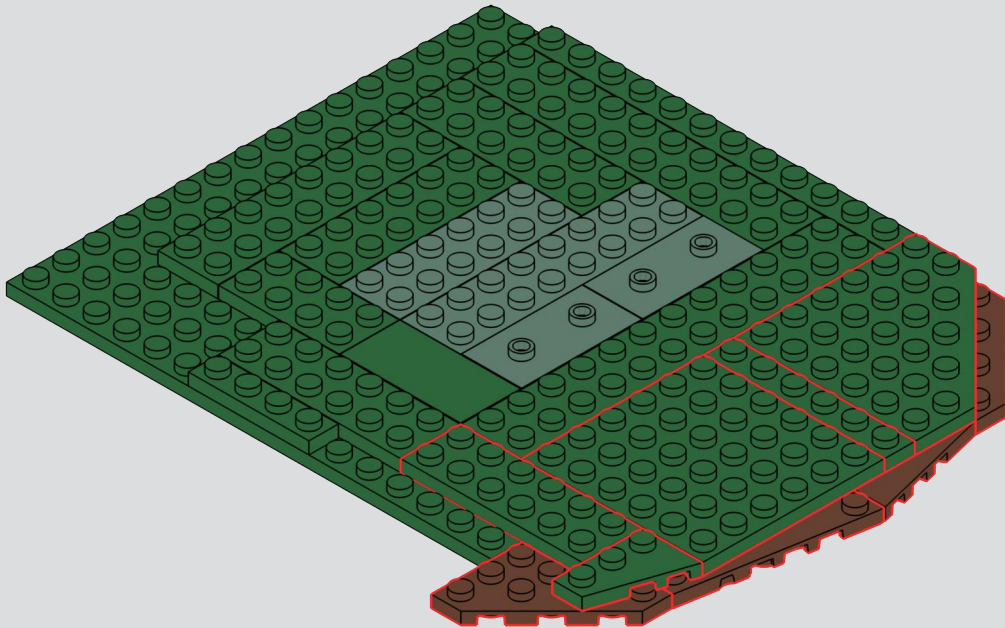

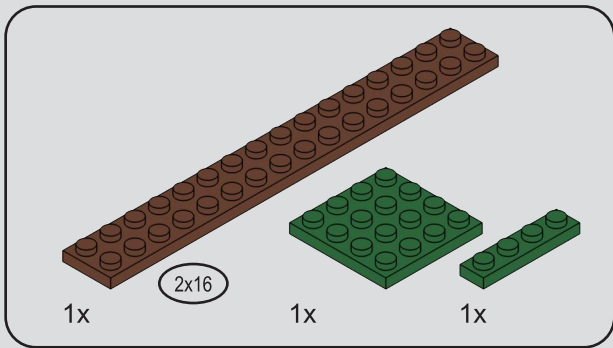

10

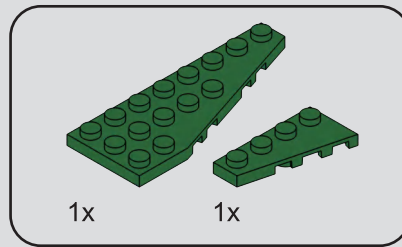
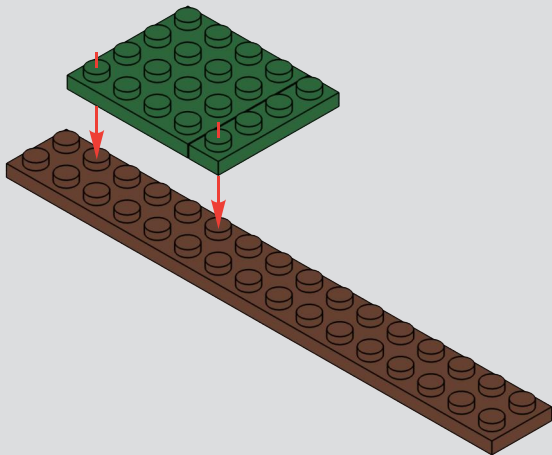

11

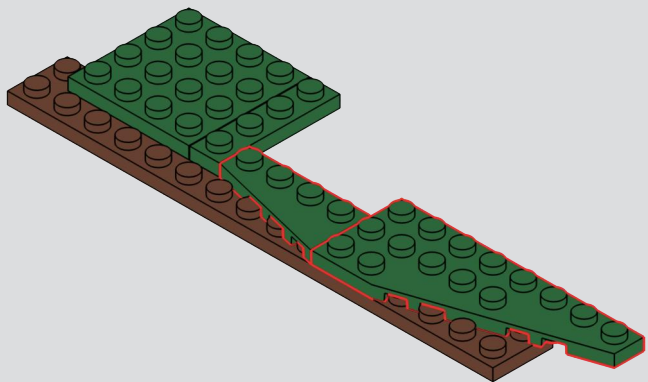

12

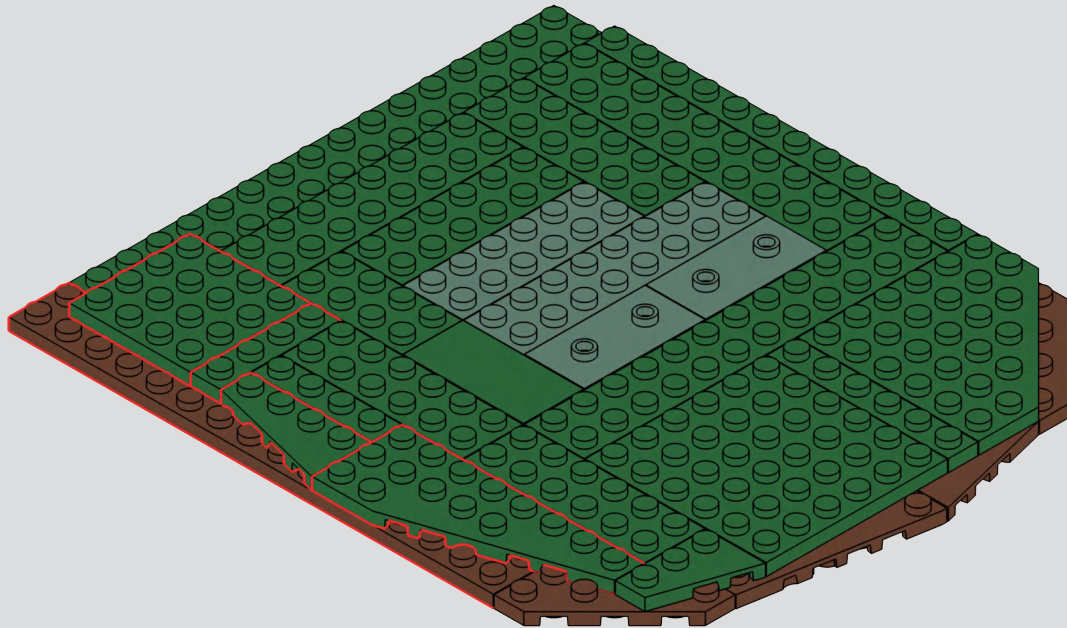

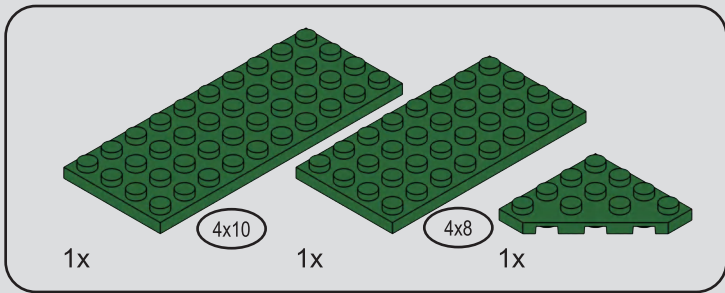

13

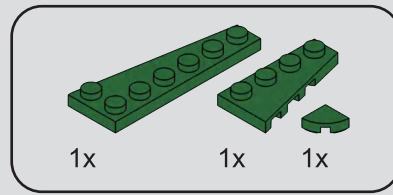
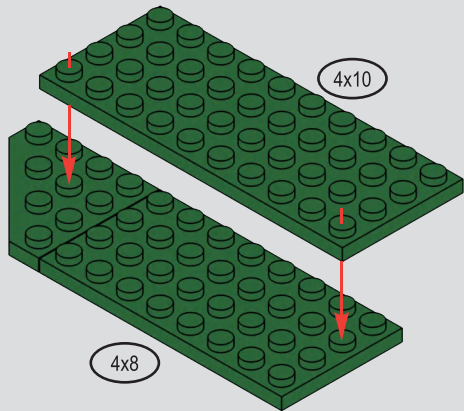

14

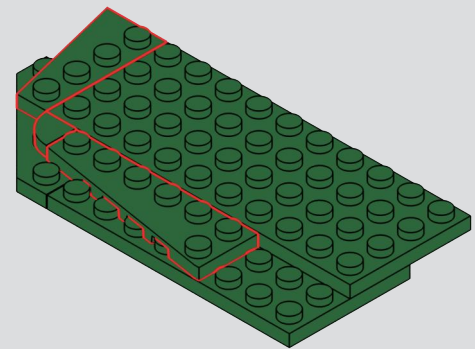

15

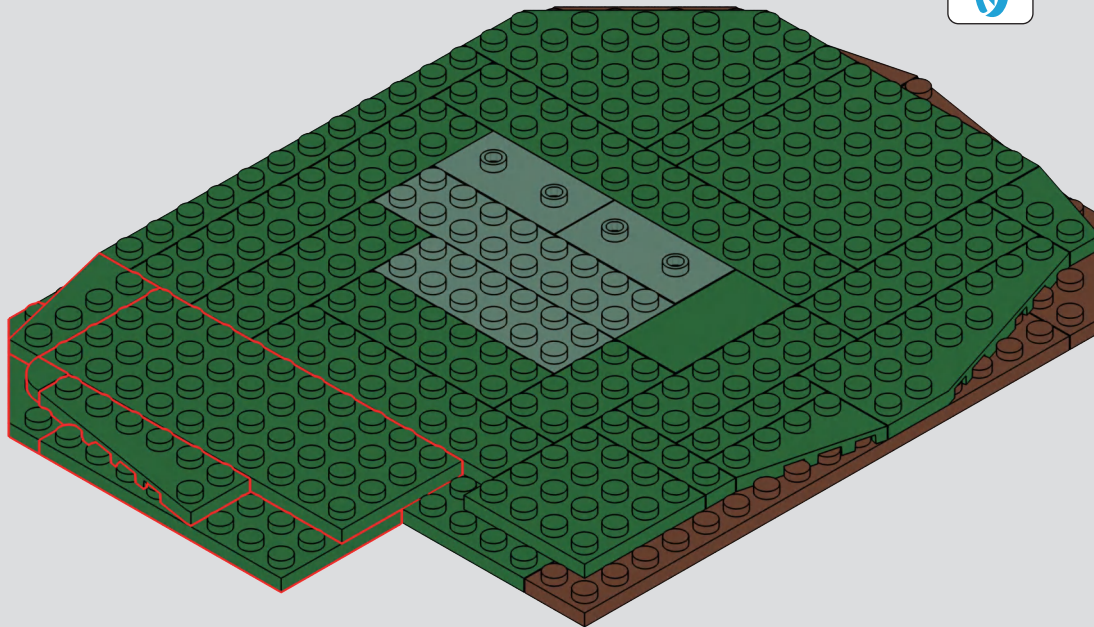

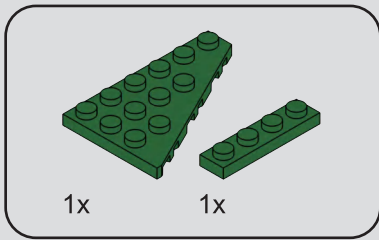

16

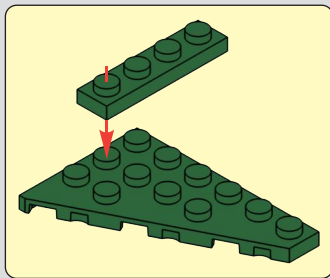
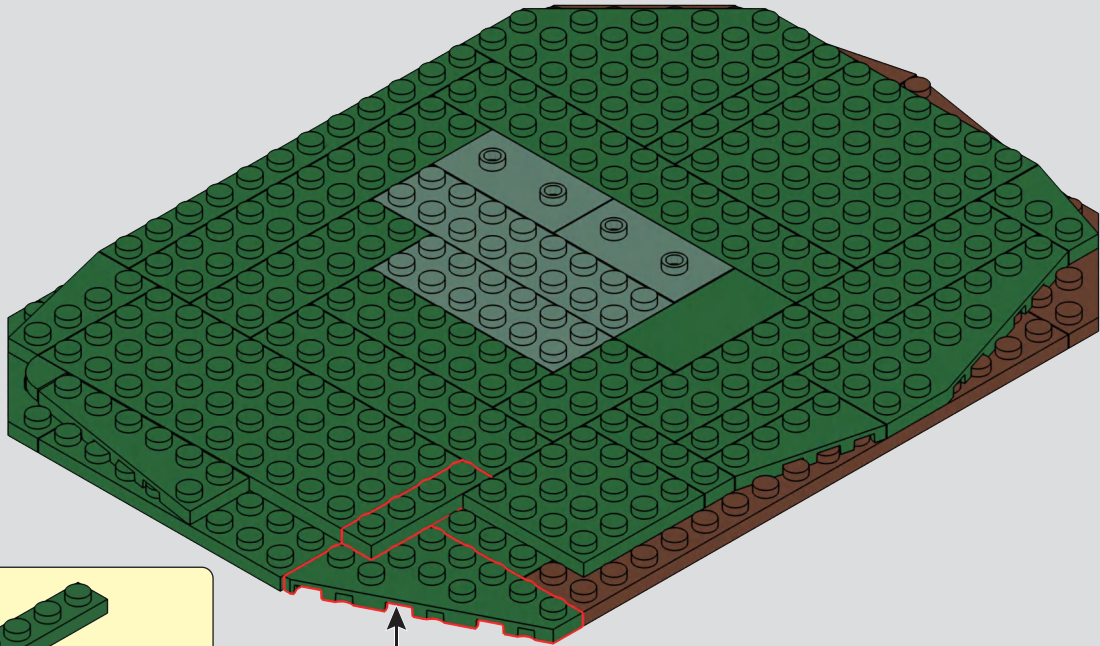

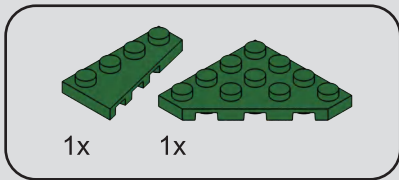

17

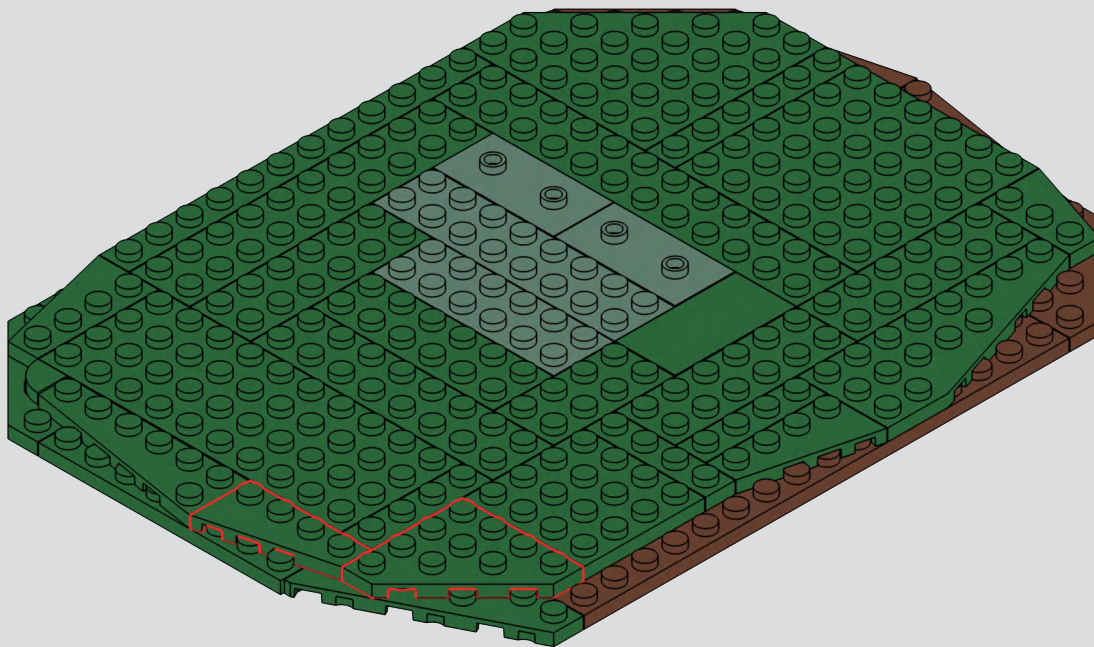

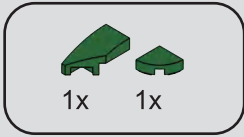

18

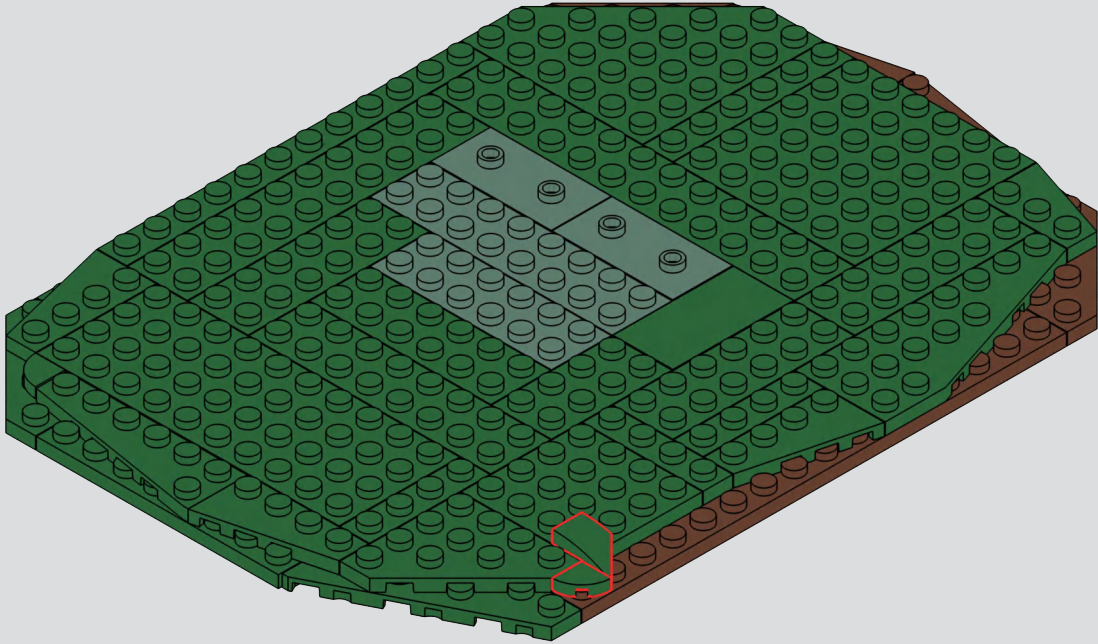



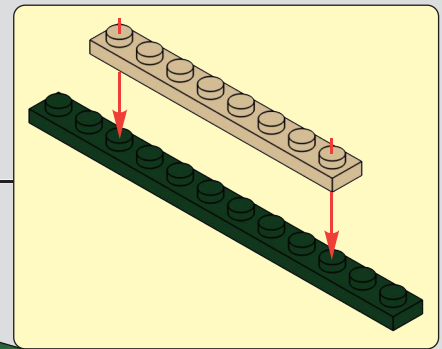
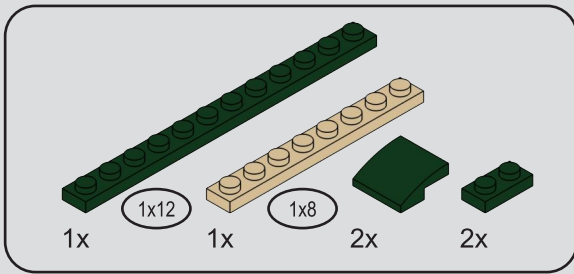

19

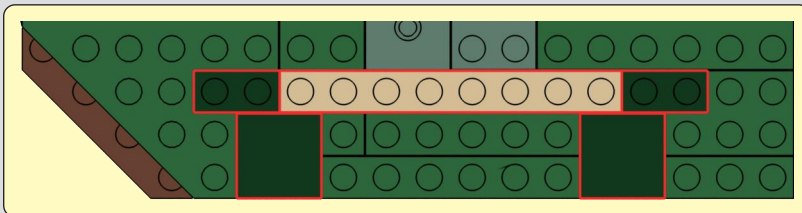
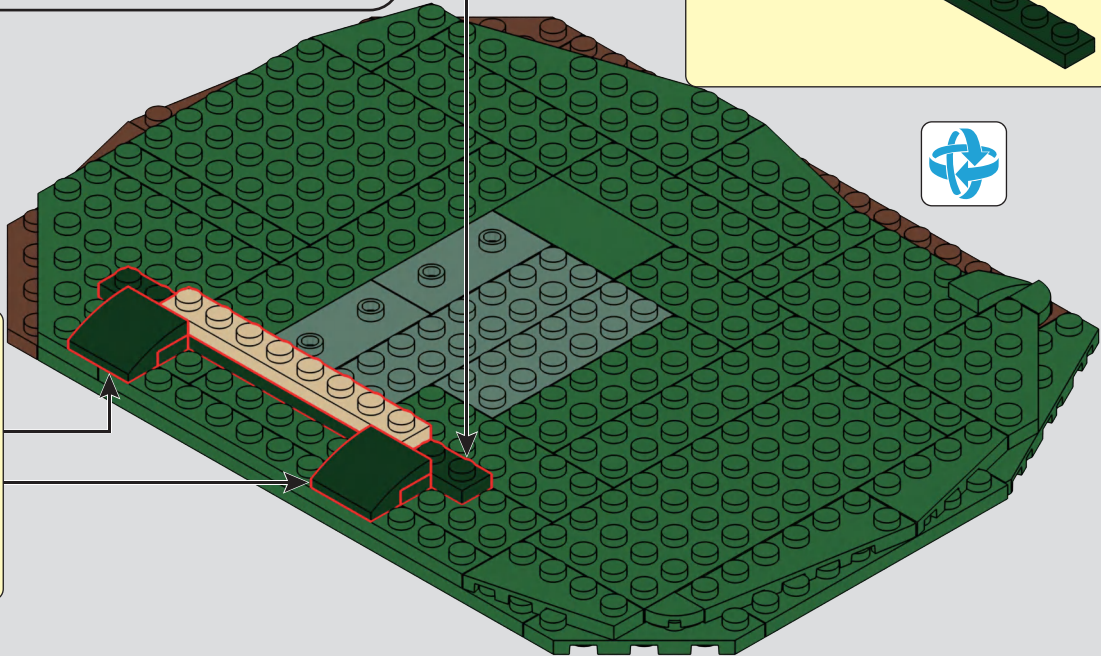
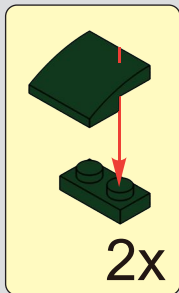

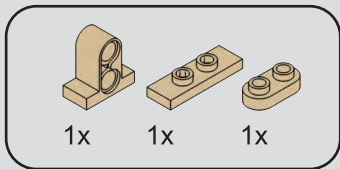

20

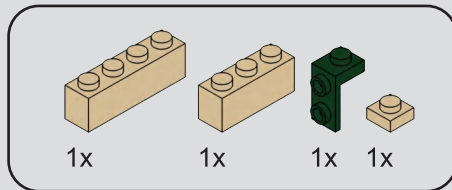
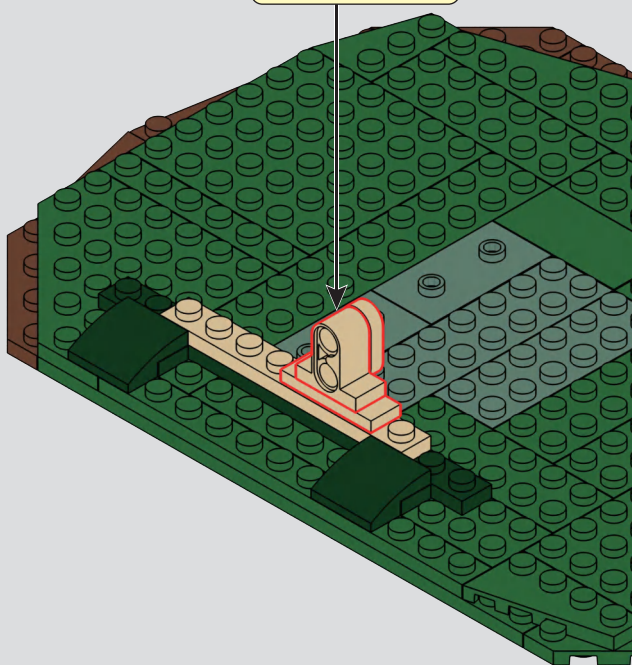
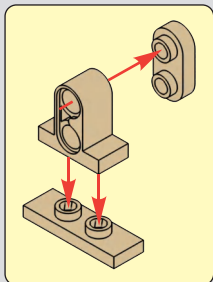

21

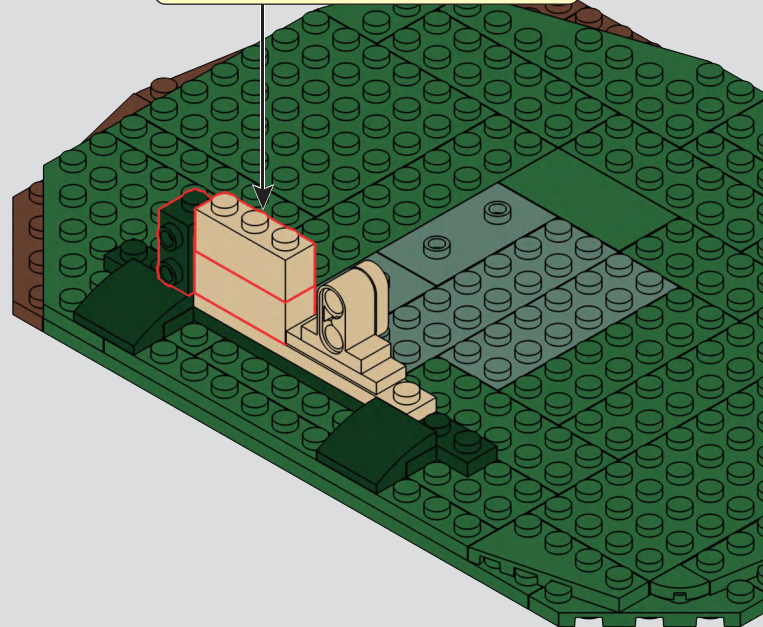
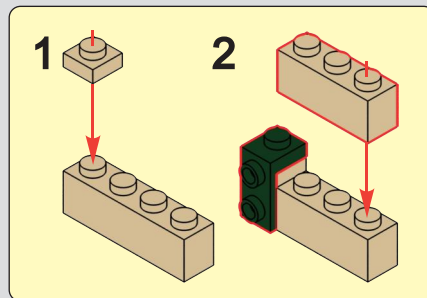

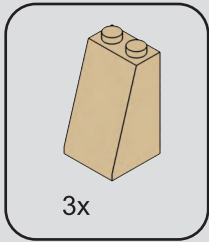

22

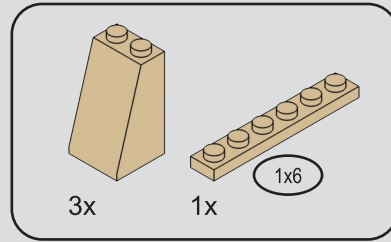
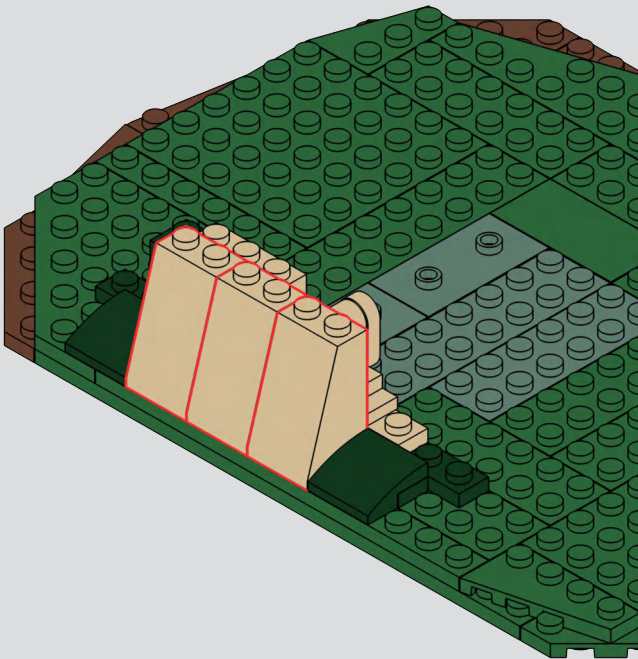

23

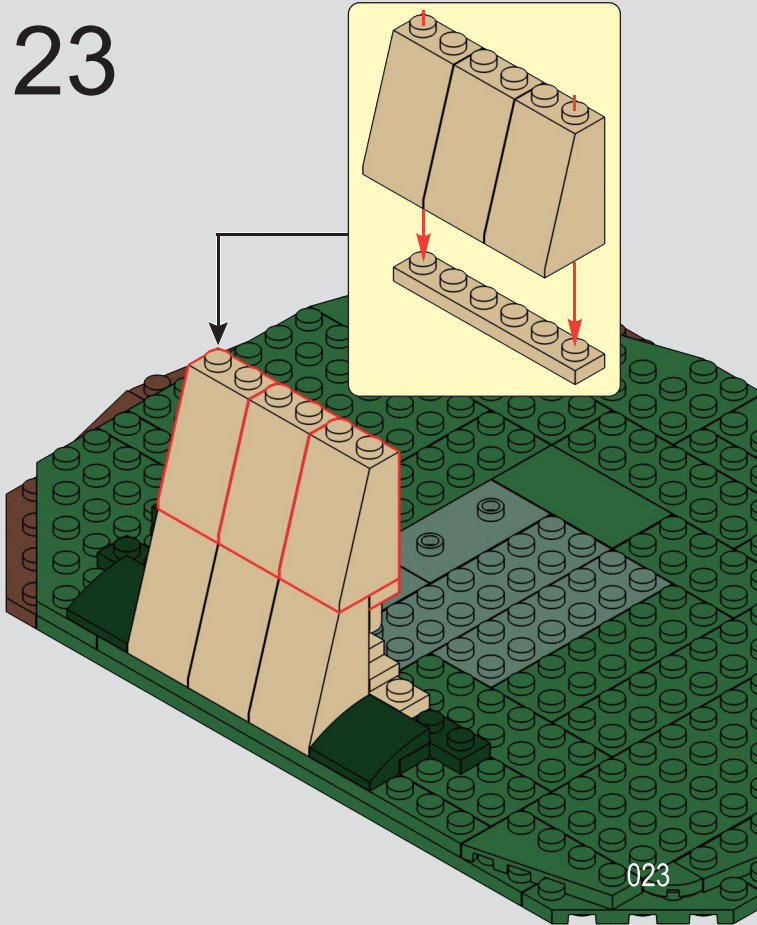

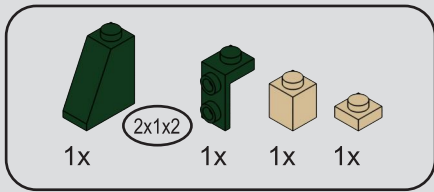

24

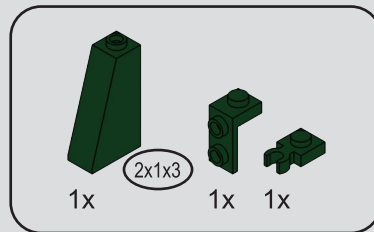
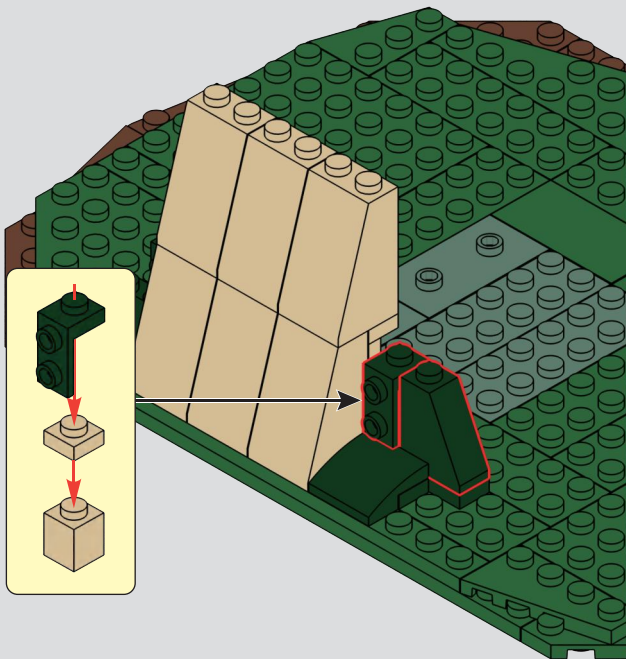

25

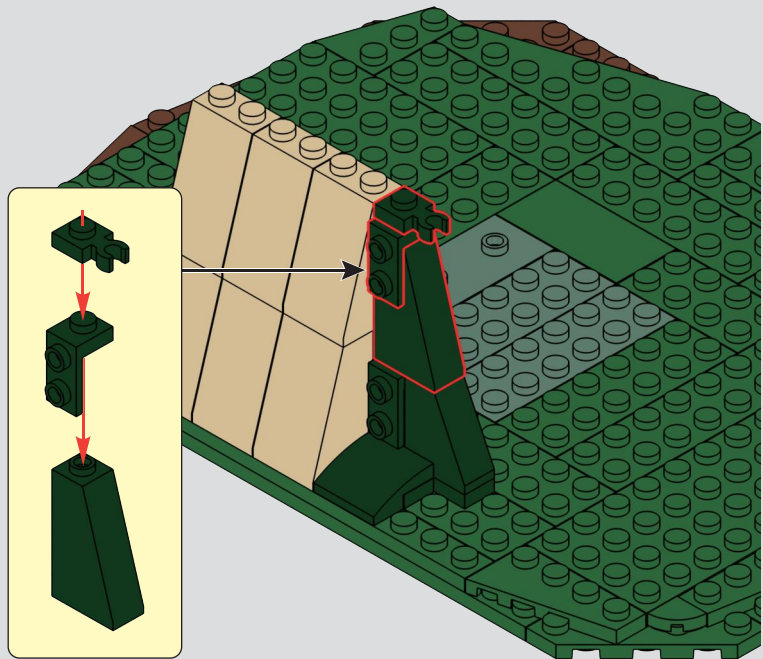

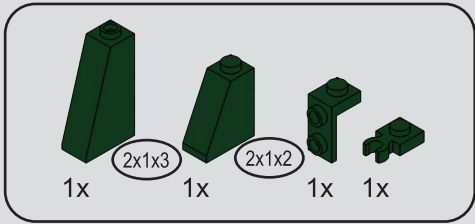

26

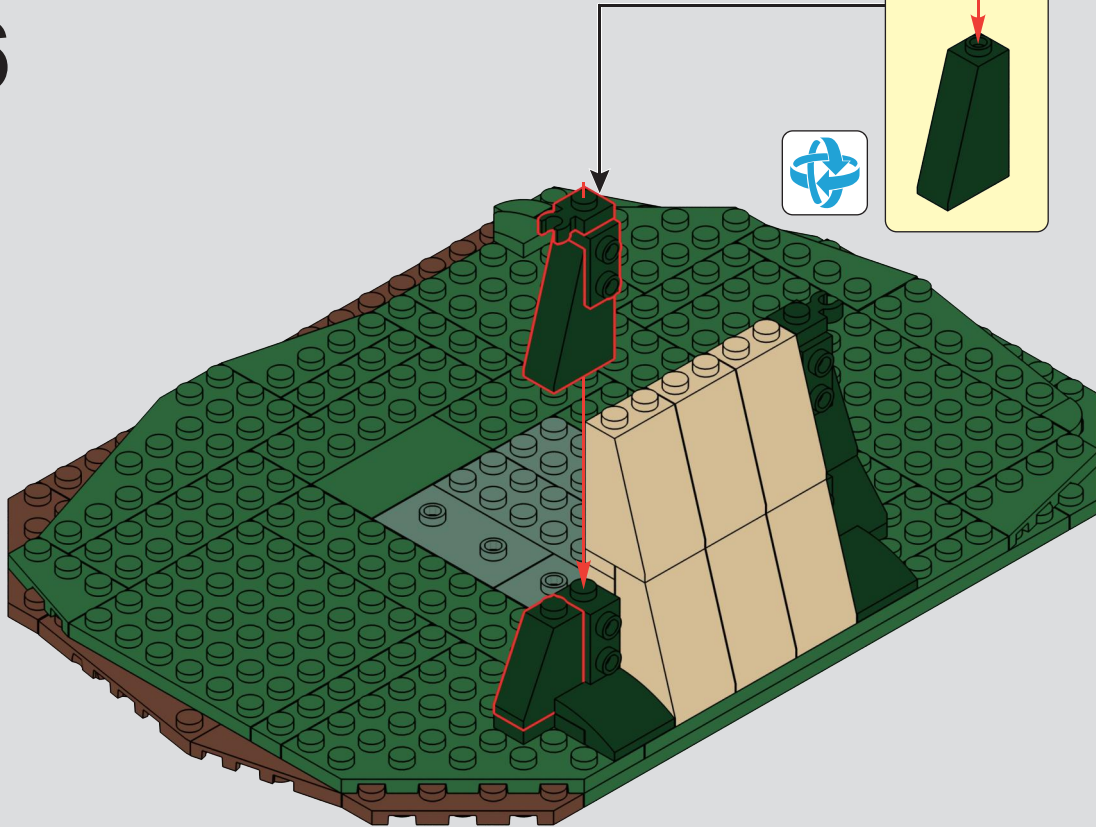
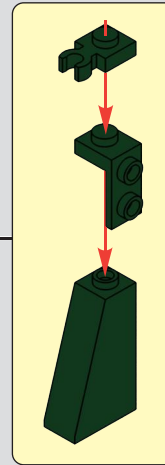

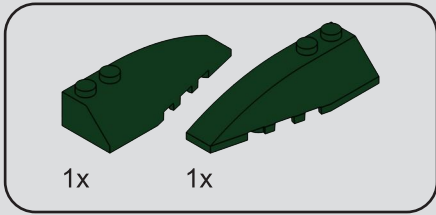

27

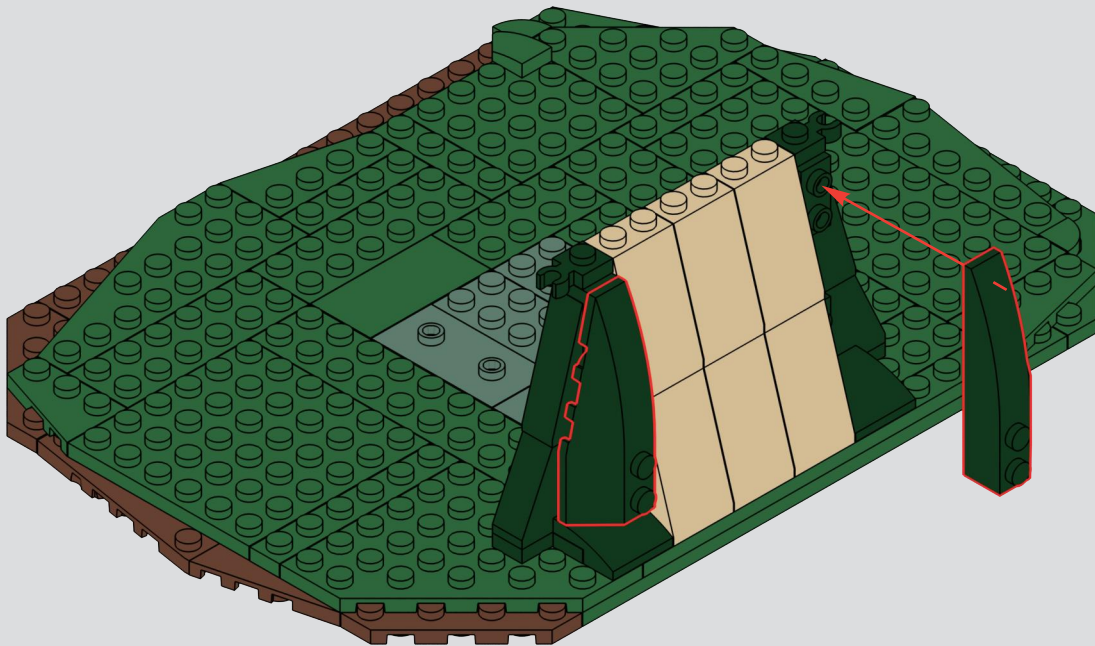

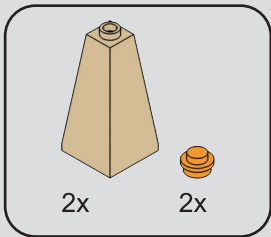

28



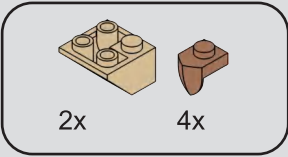

29

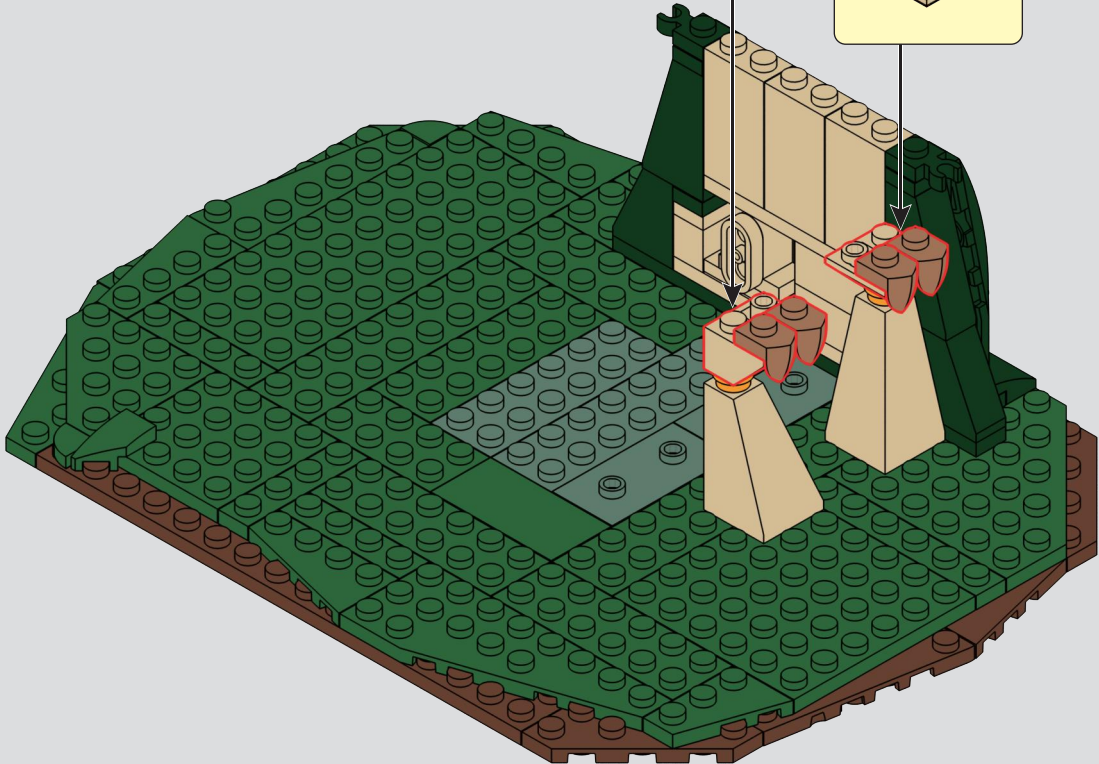
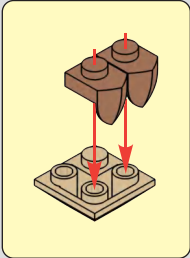
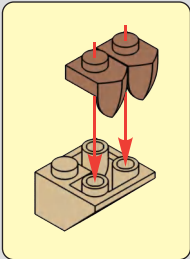

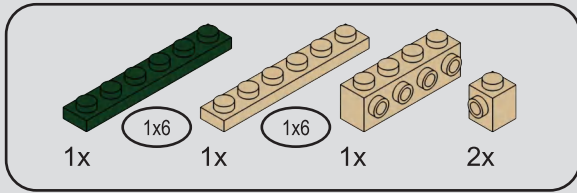

30

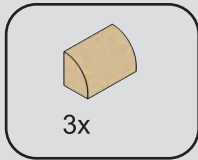
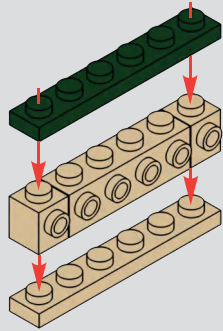

31

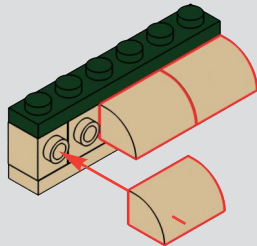

32

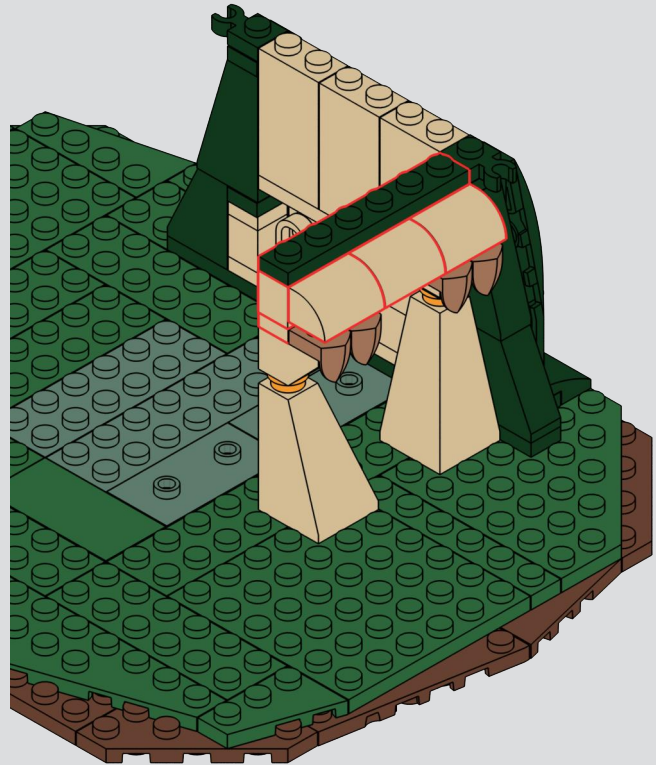

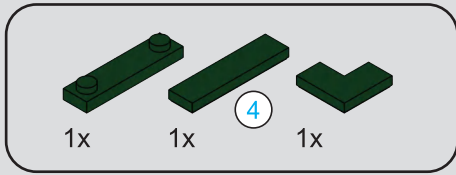

33

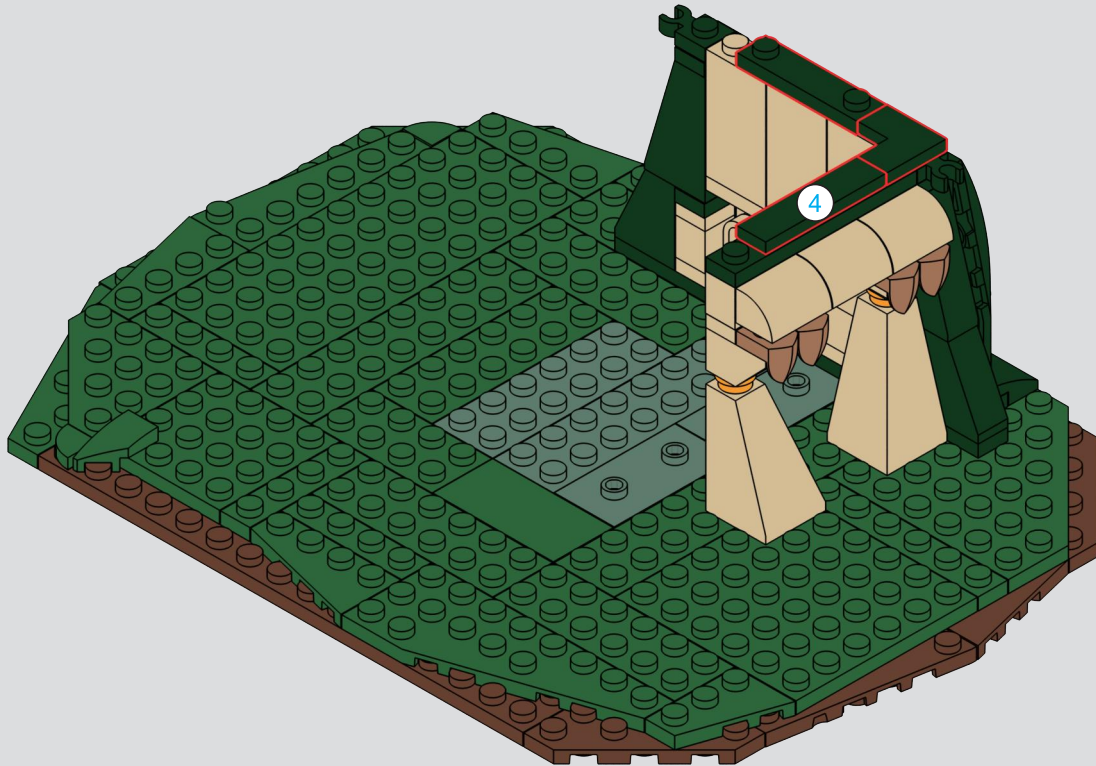

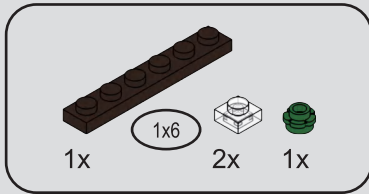

34

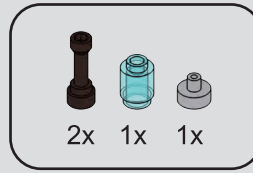
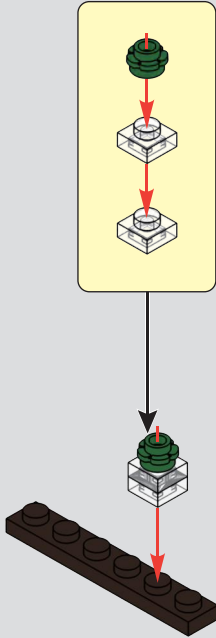

35

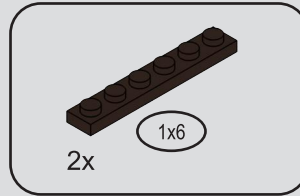
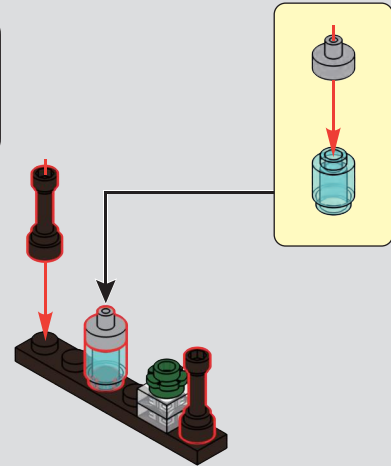

36

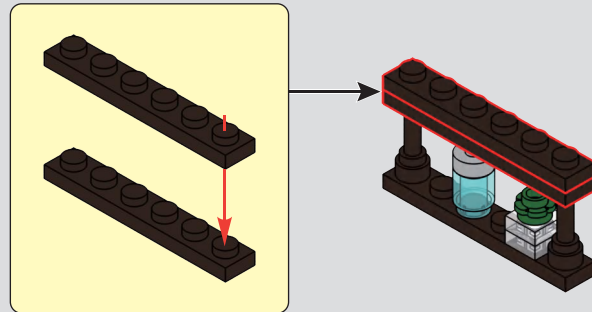

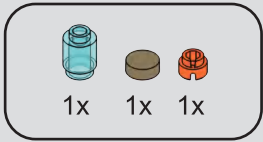

37

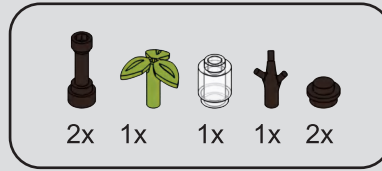
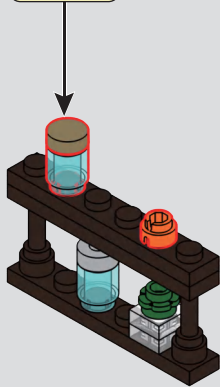
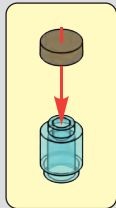

38

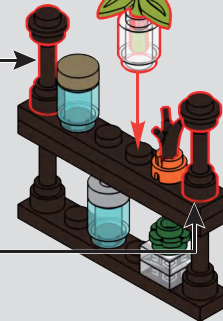
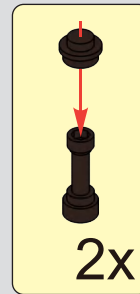
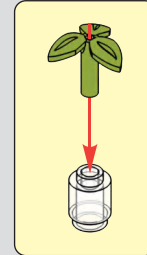

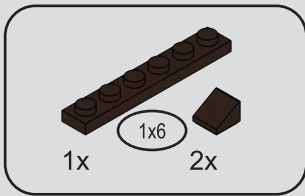

39

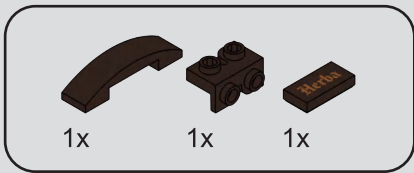
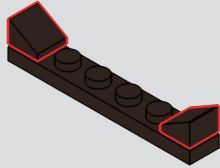

40

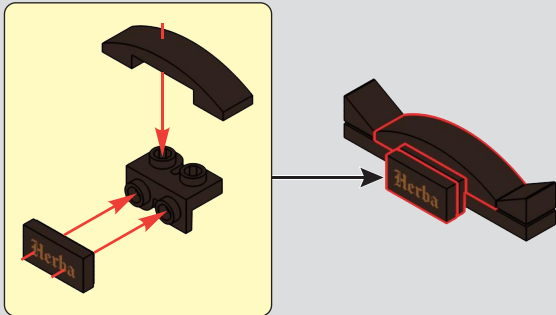

41



42

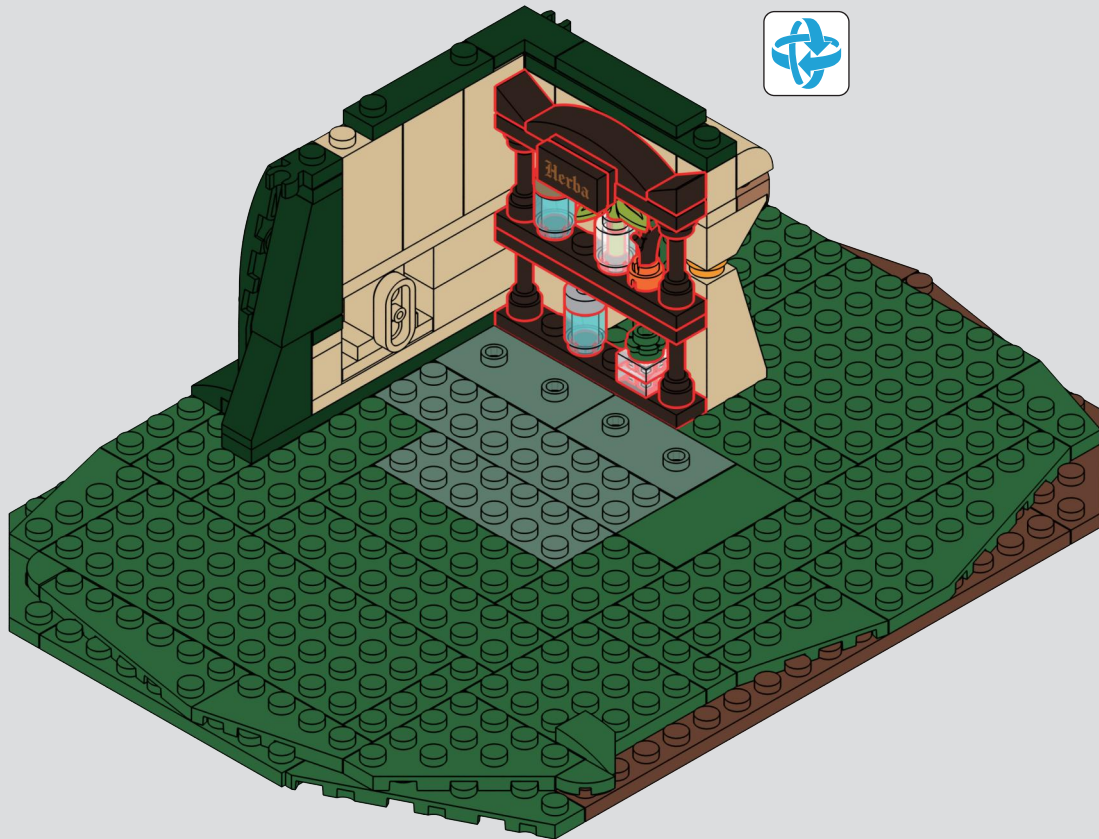

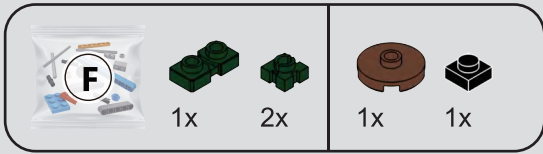

43

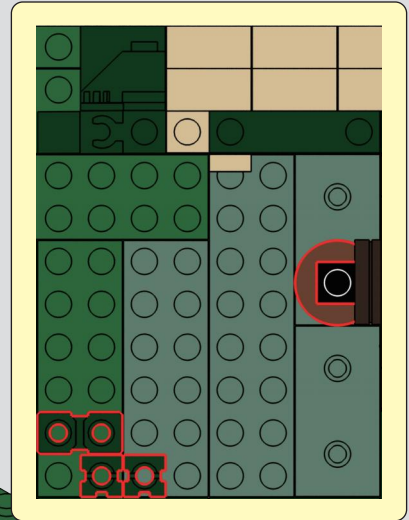
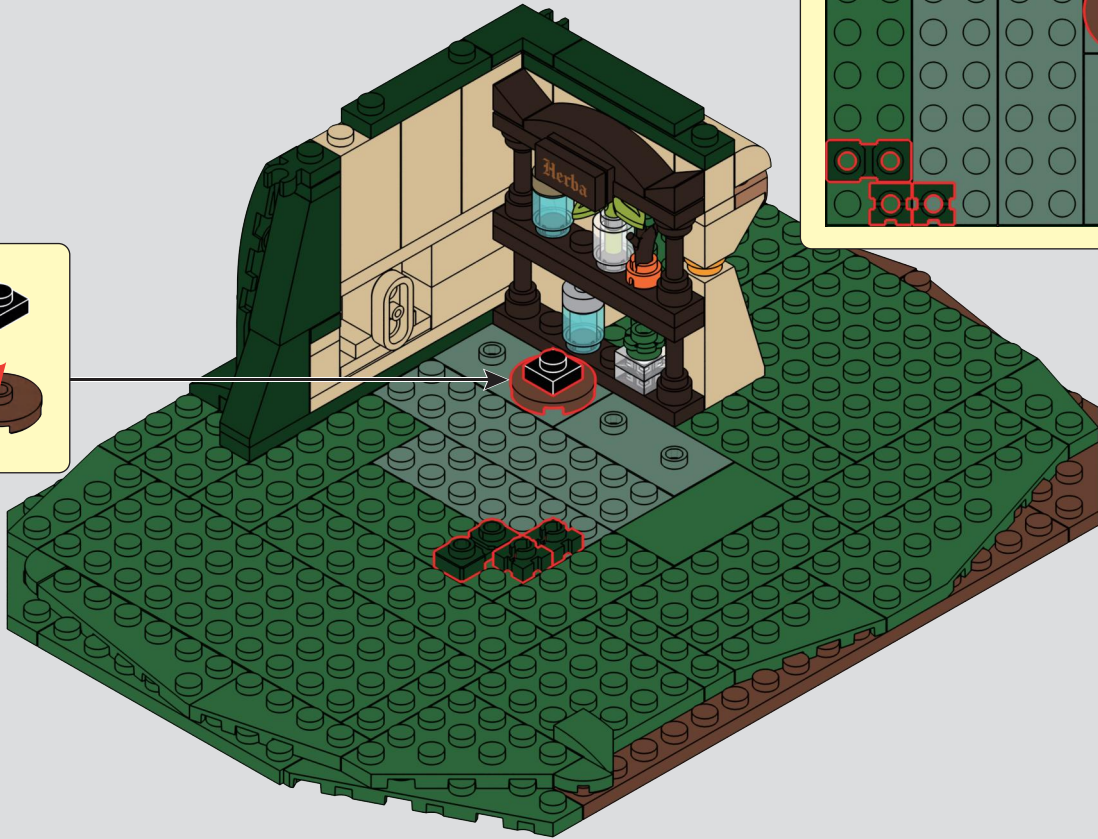
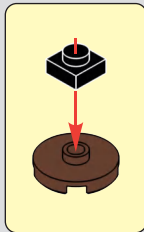

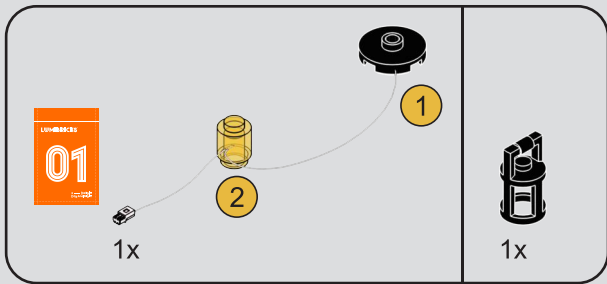

44

1

2

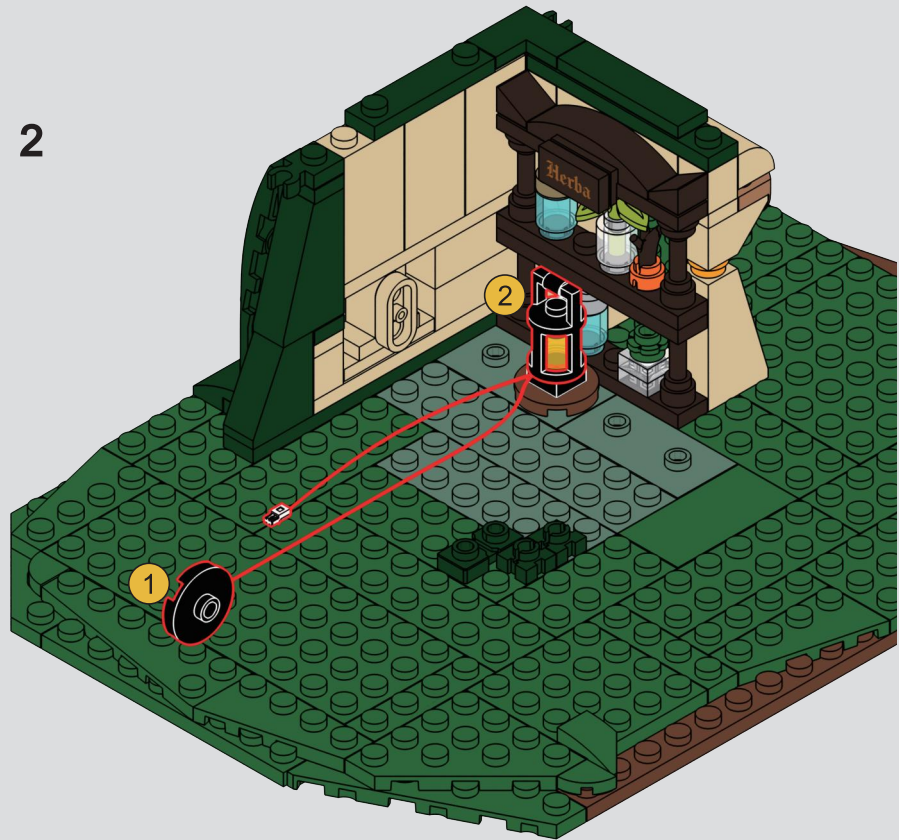
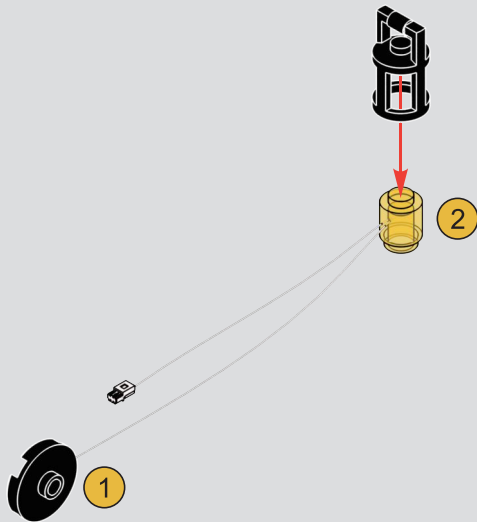

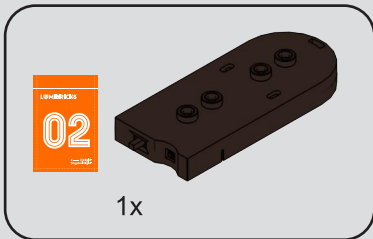

45

1

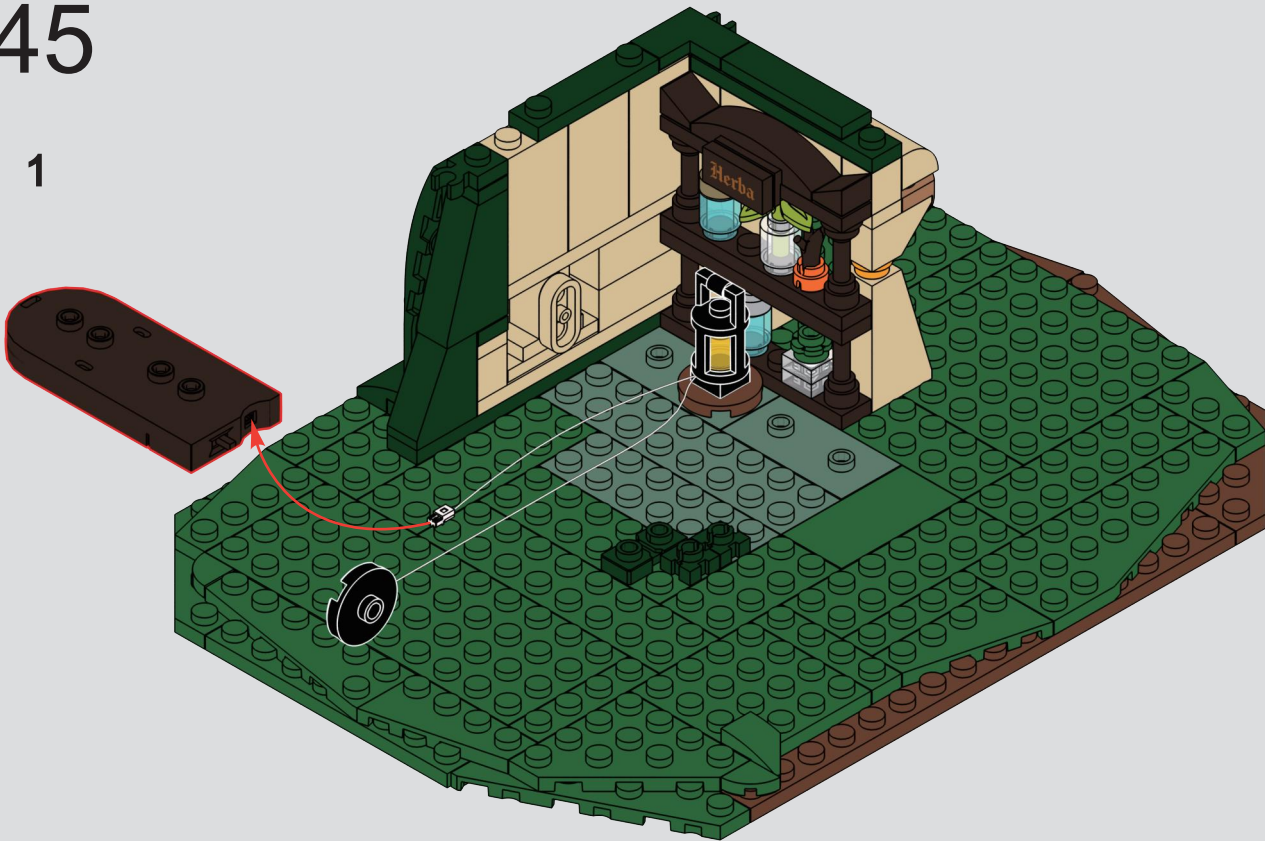

2

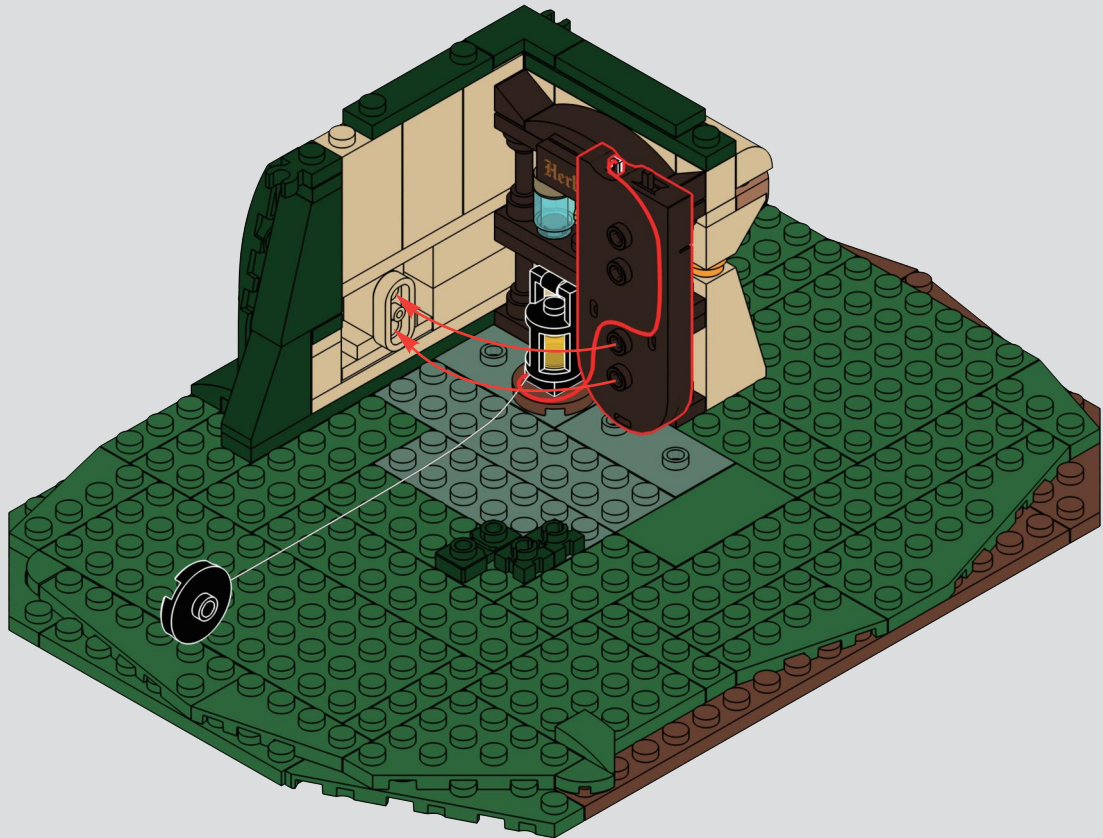

3

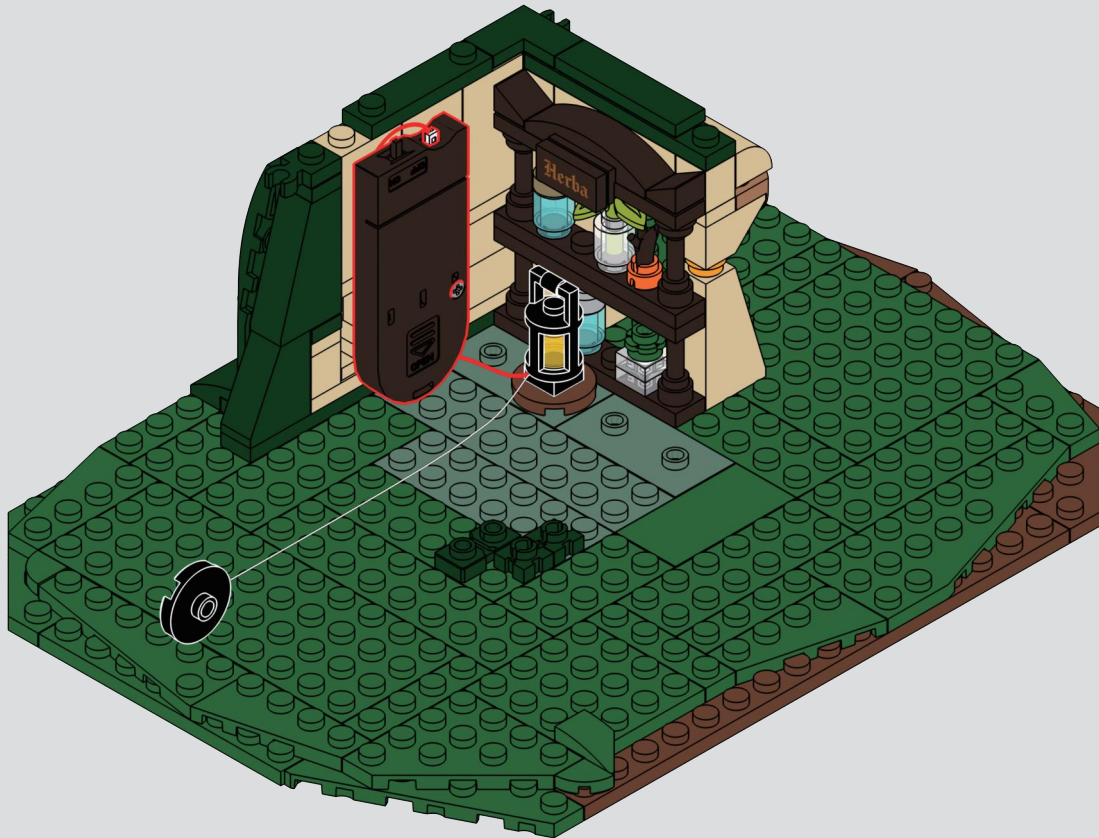

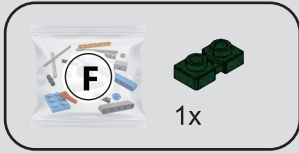

46

1

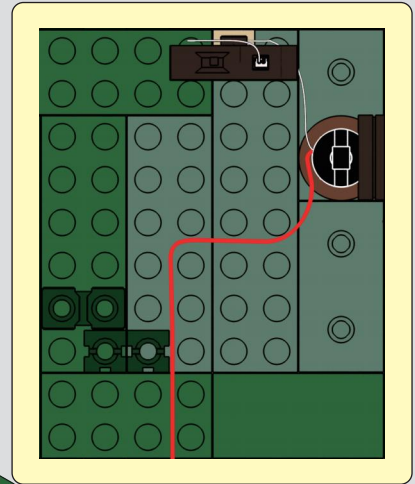

1

2

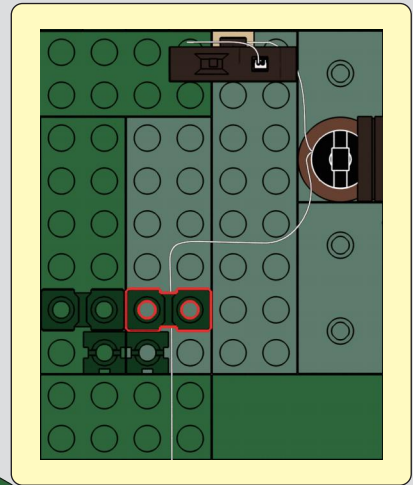

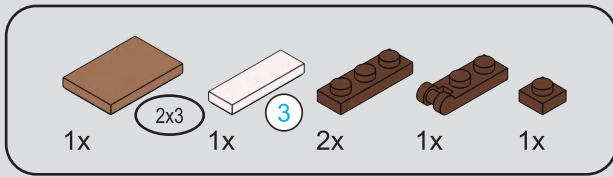

47

1

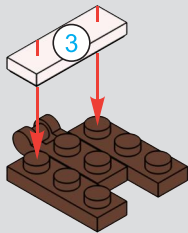

2

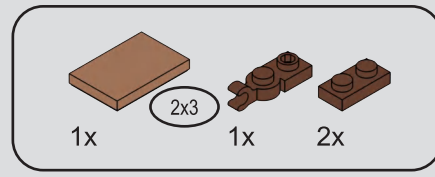
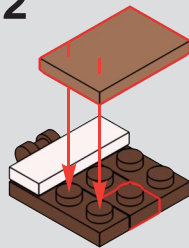

48

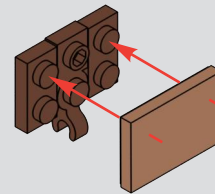

49

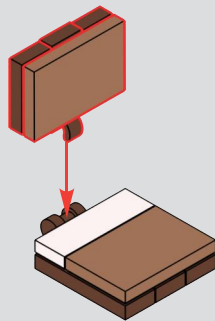

50

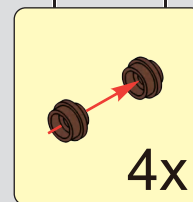
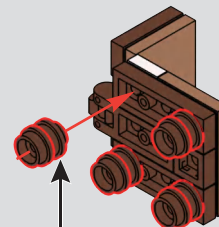

51

1



2



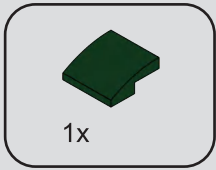

1

52



2



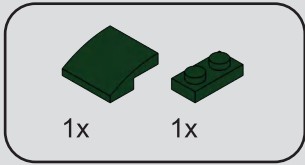

53

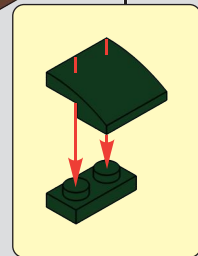
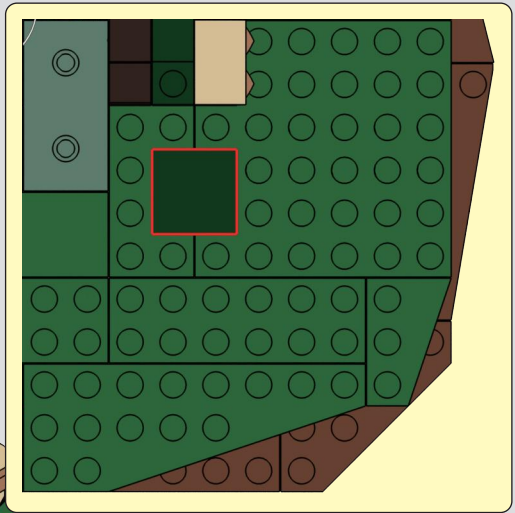

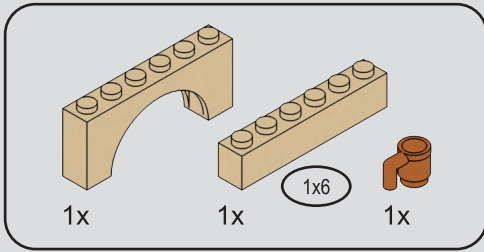

54

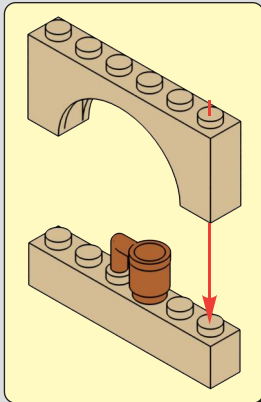

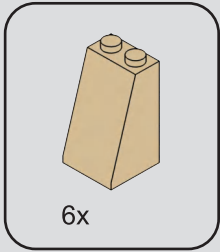

55

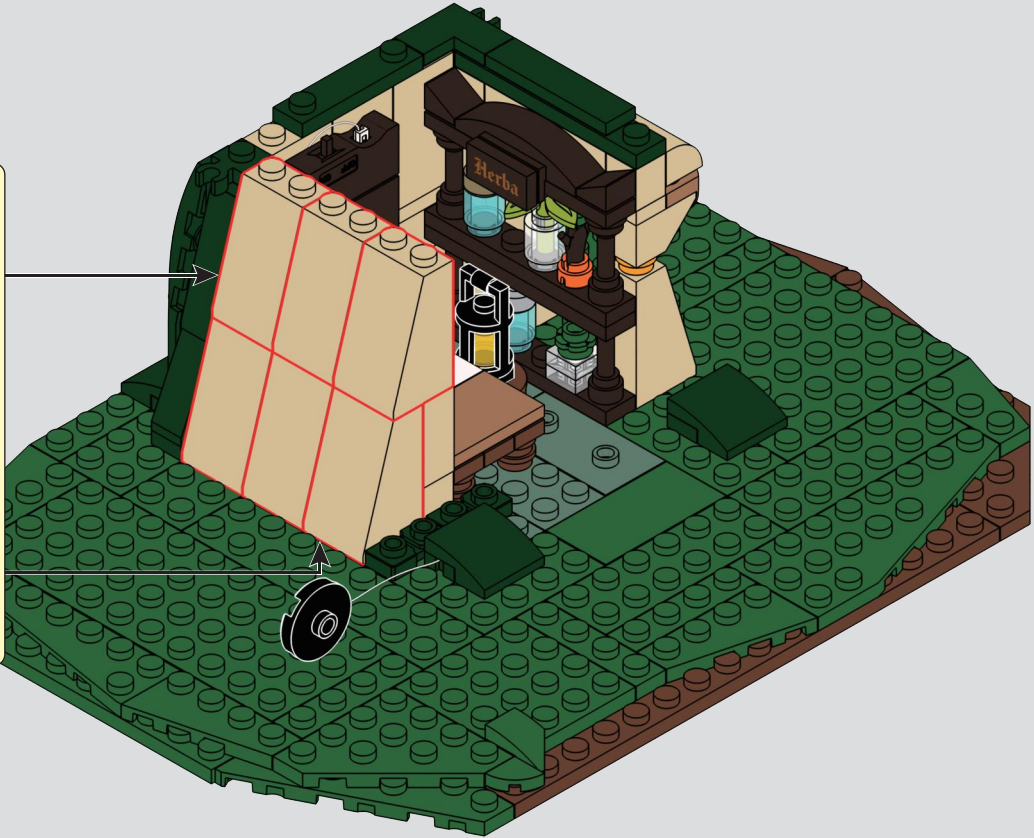
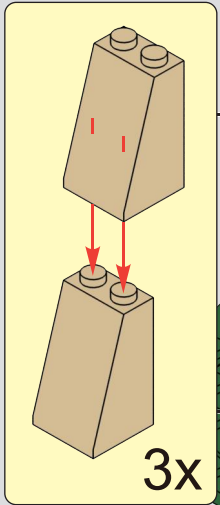

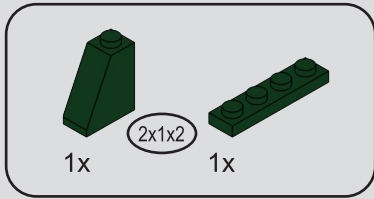

56

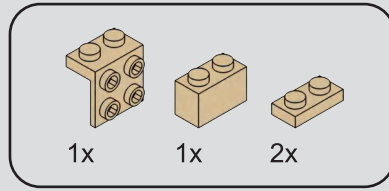
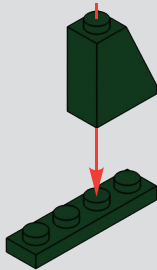

57

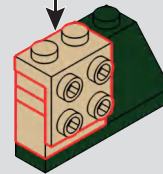
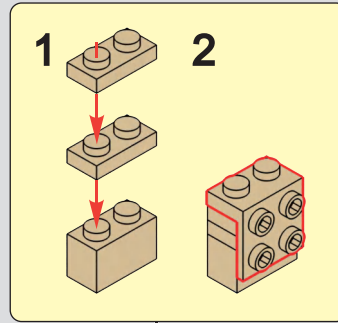

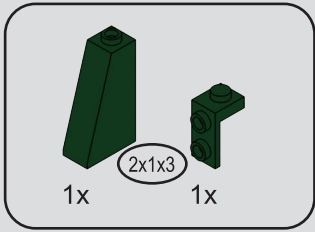

58

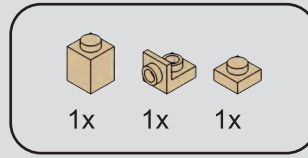
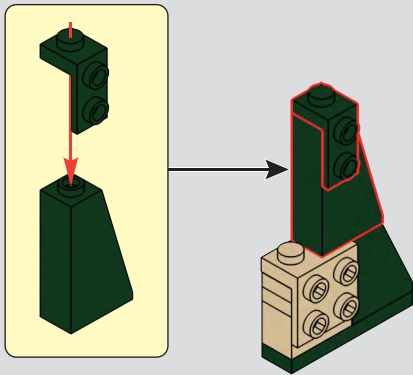

59

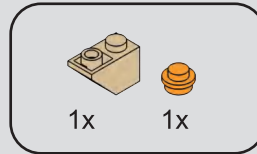

60

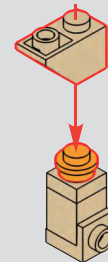

61

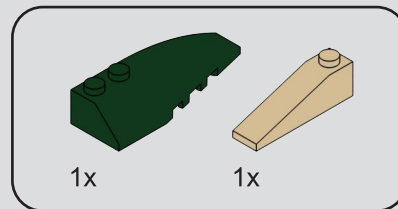
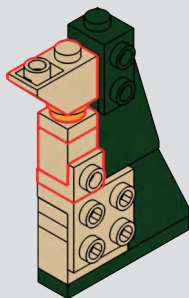

62

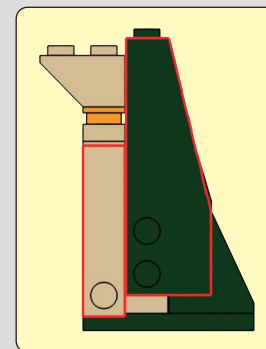
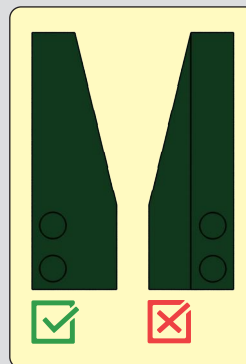
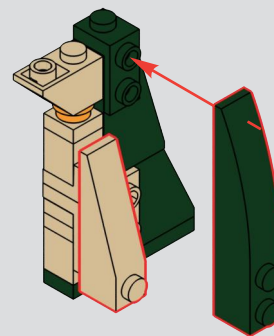

63

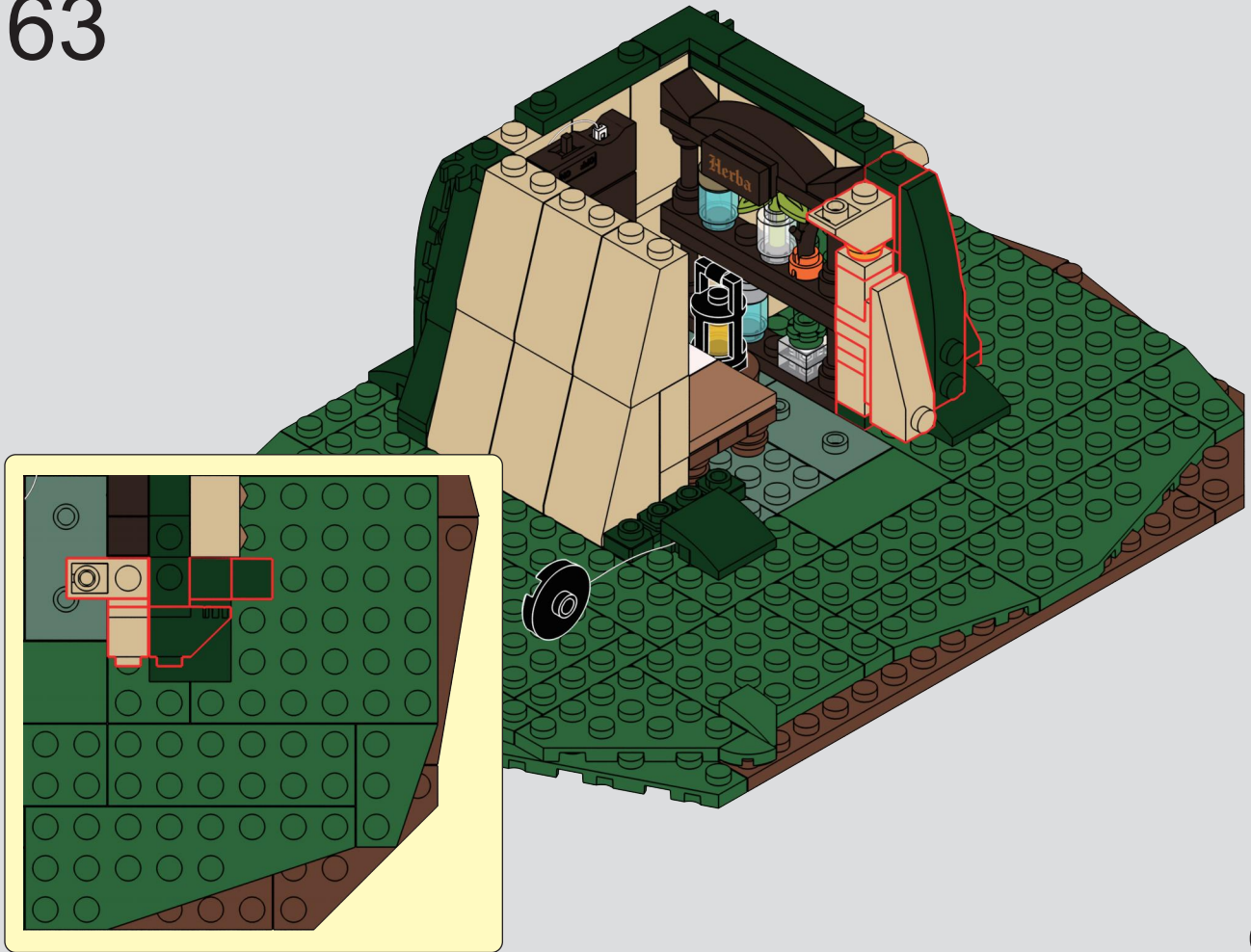

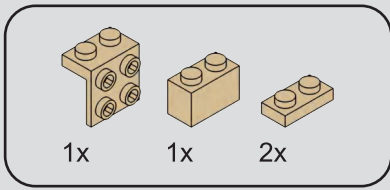

64

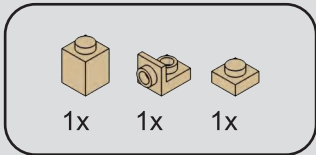
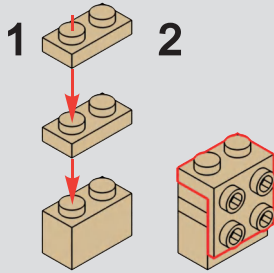

65

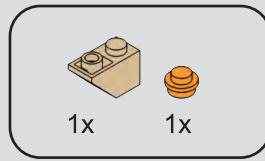

66

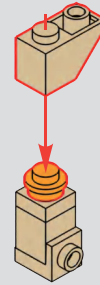

67

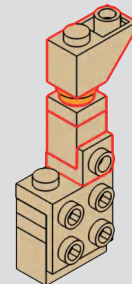

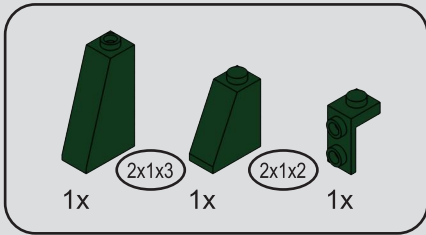

68

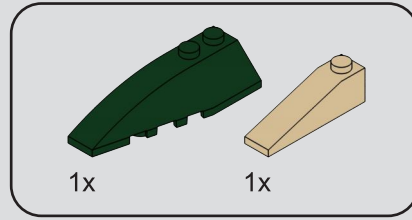
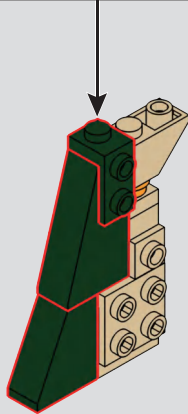
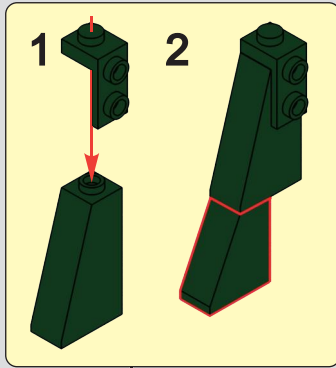

69

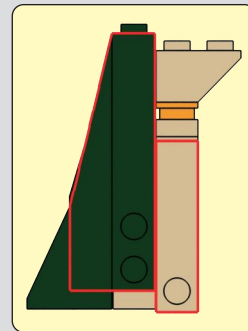
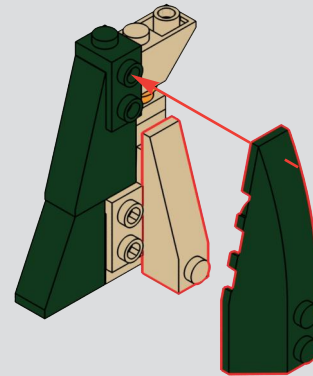

70

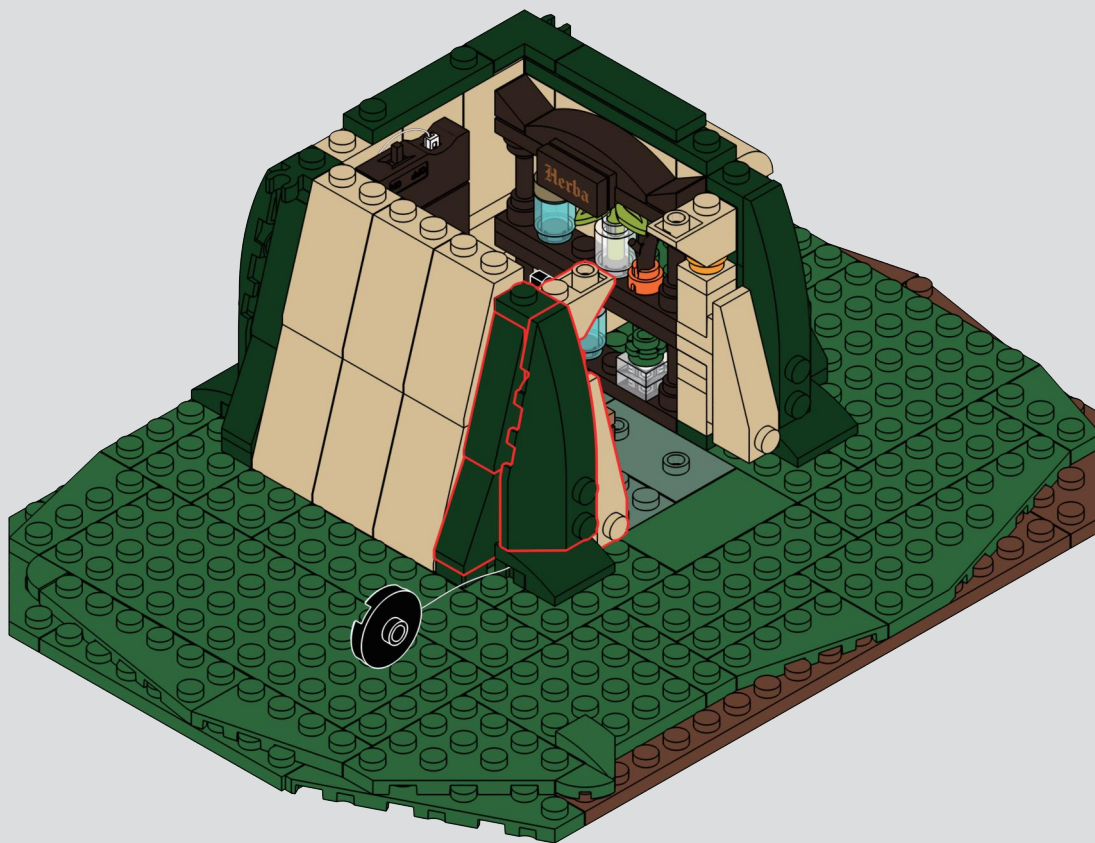

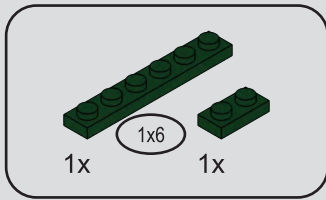

71

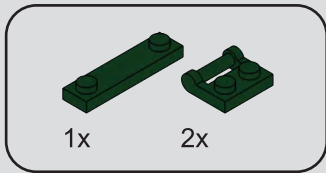
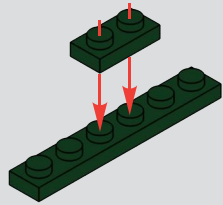

72

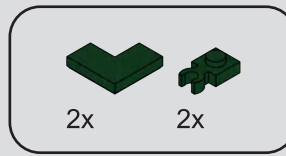
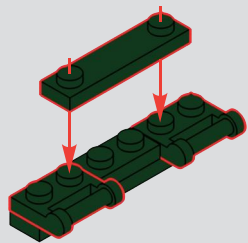

73

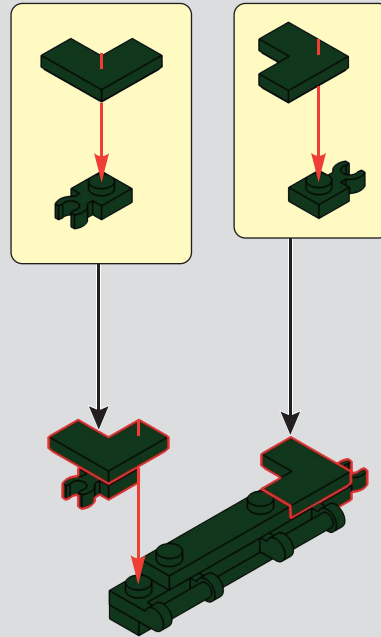

74

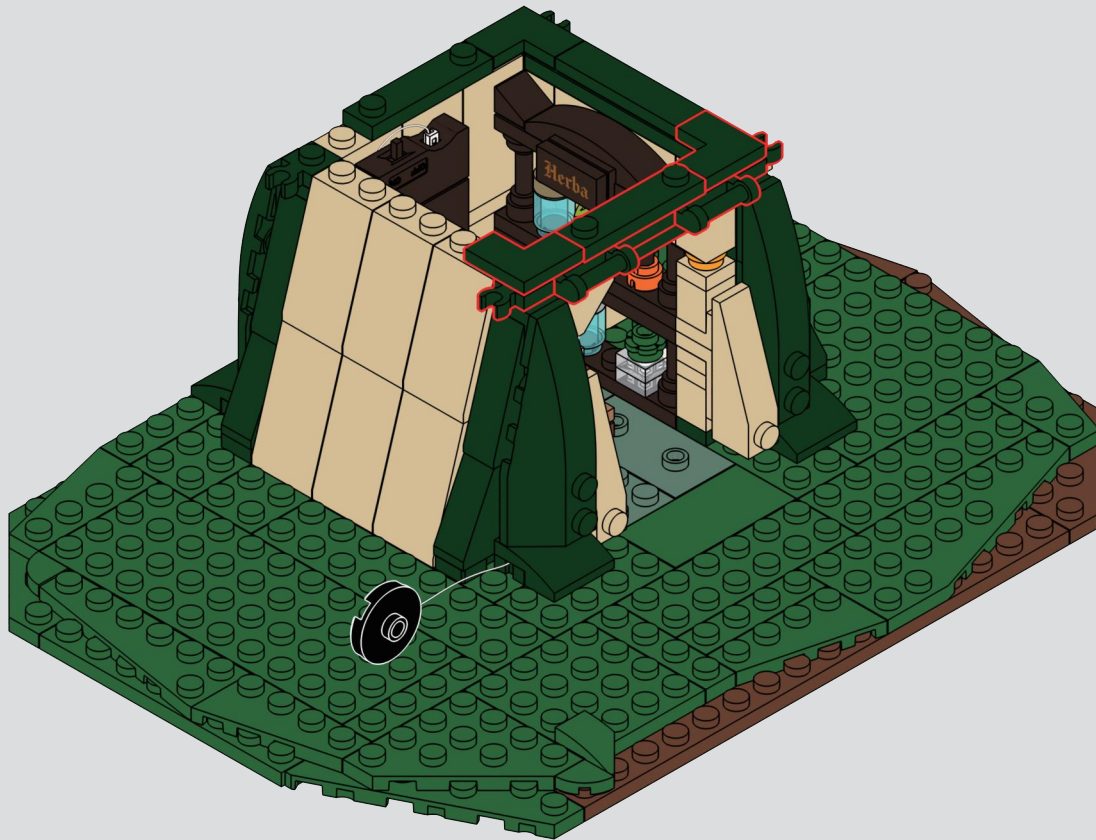

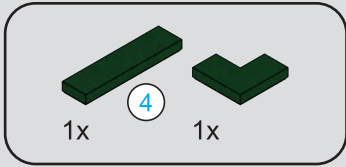

75

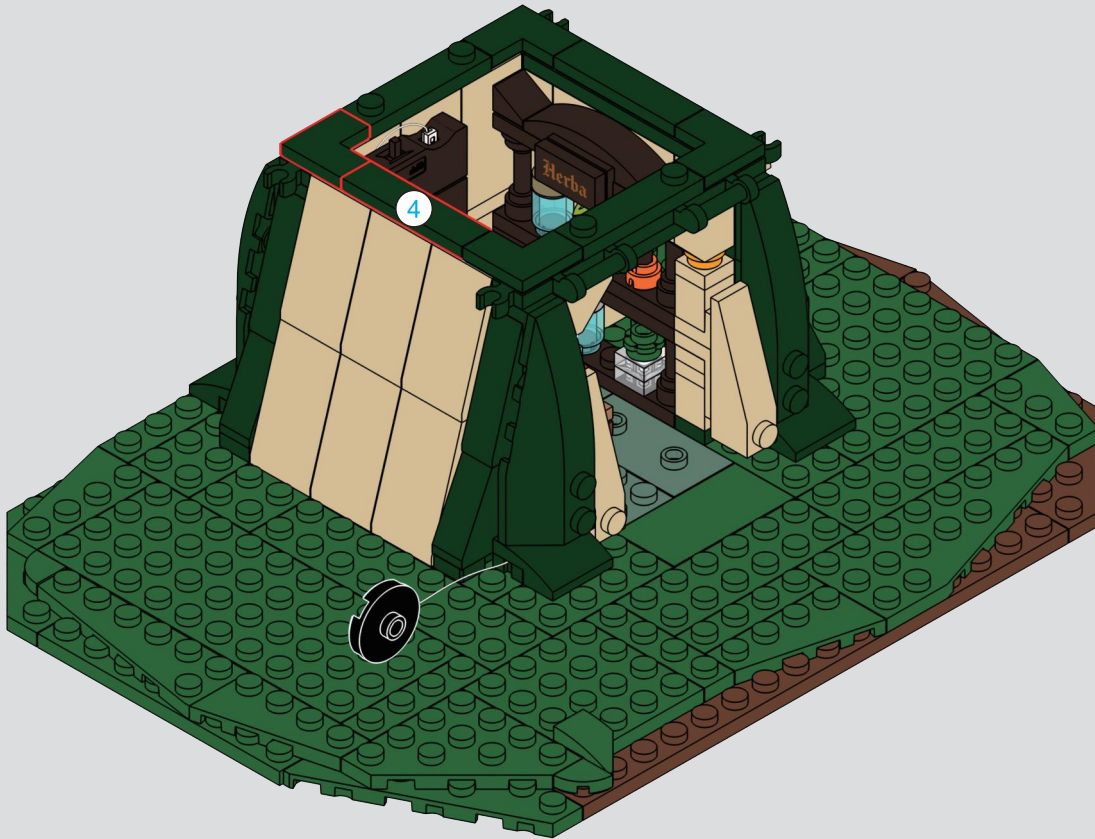

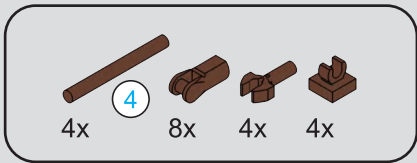

76

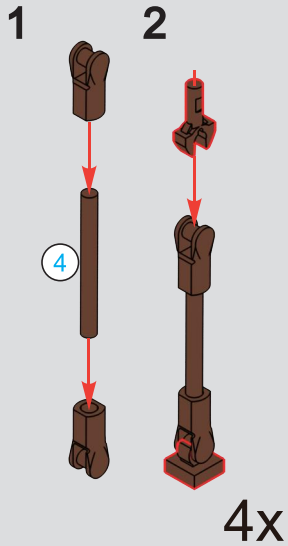

060



77

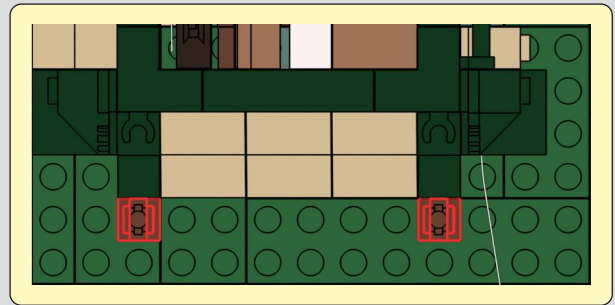

1

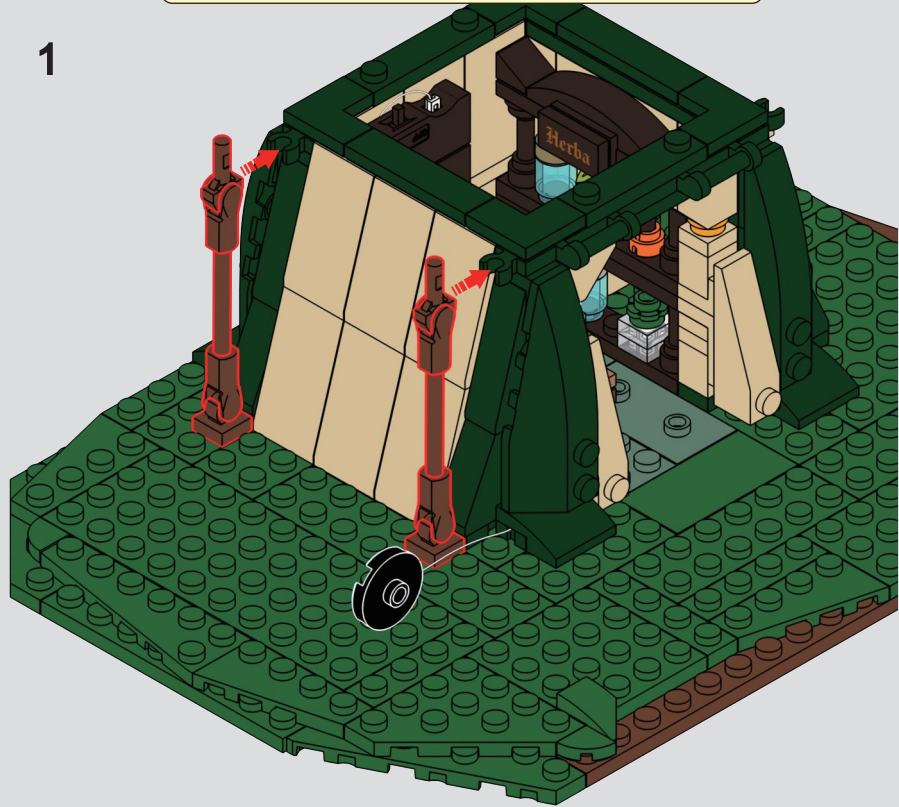

2

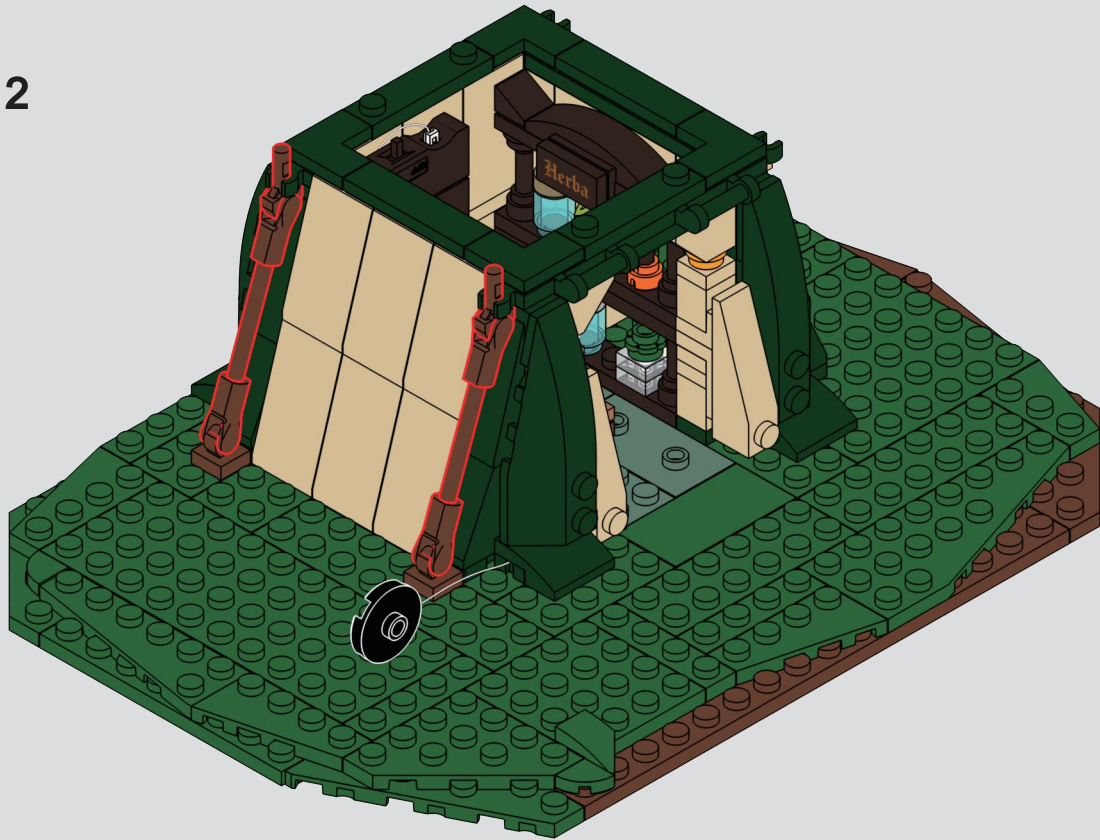

3



4



2x 1x 2x 2x

78

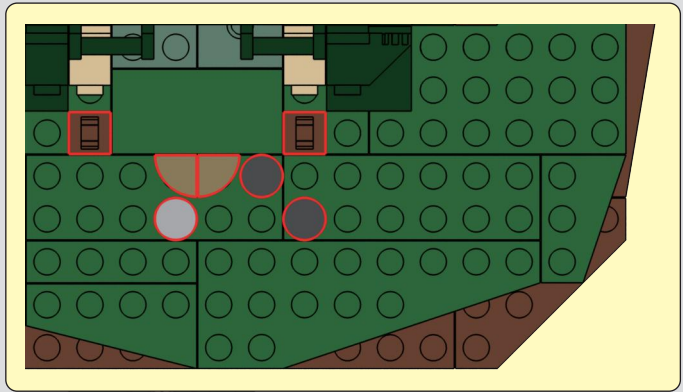

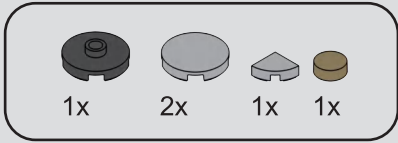

79

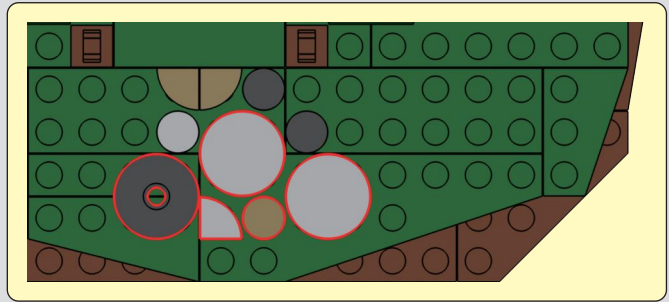

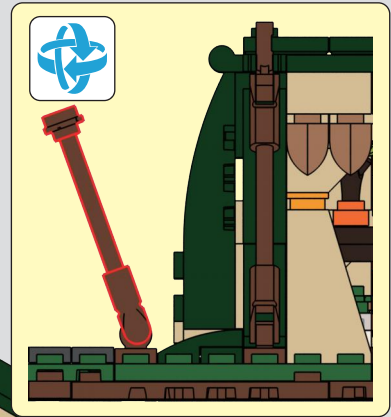
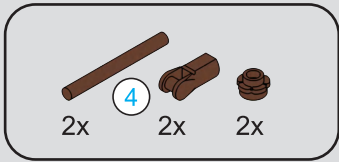

80

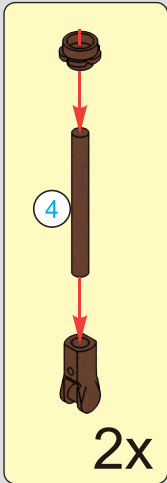

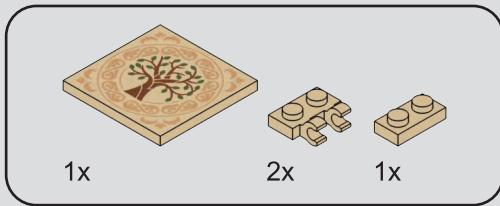

81

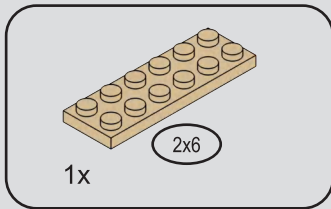
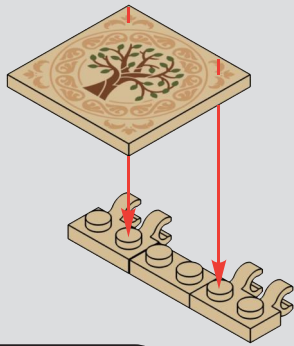

82

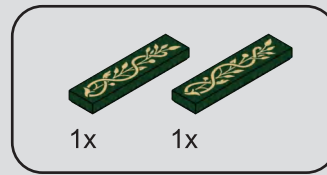
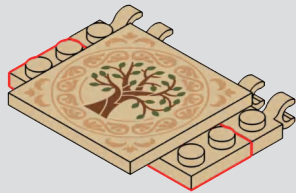

83

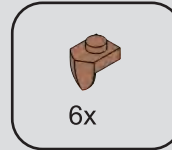

84

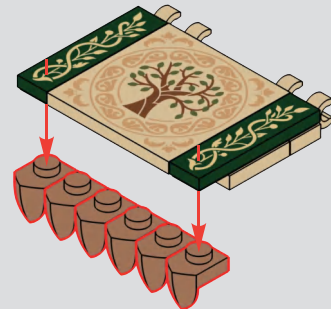

85

1



2



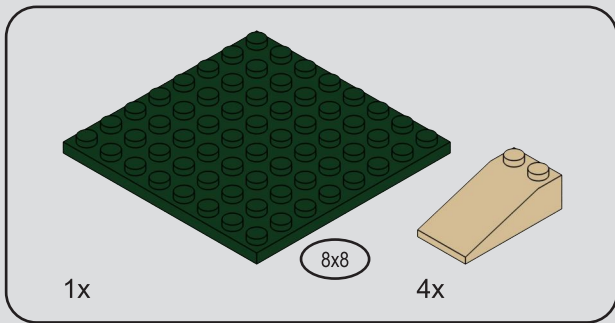

86

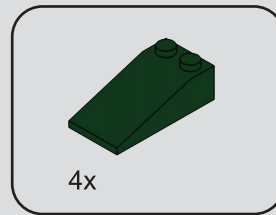
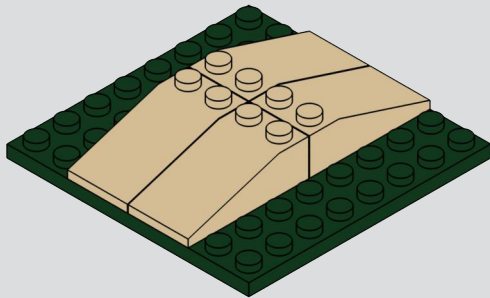

87

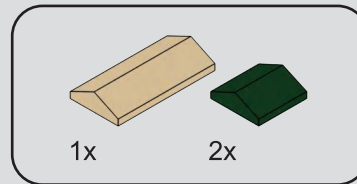
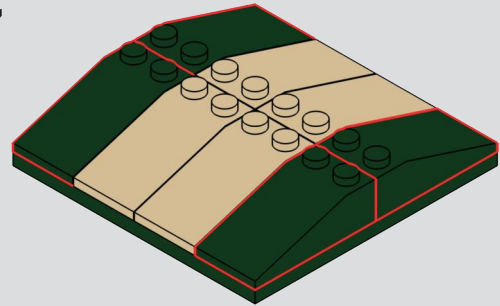

88

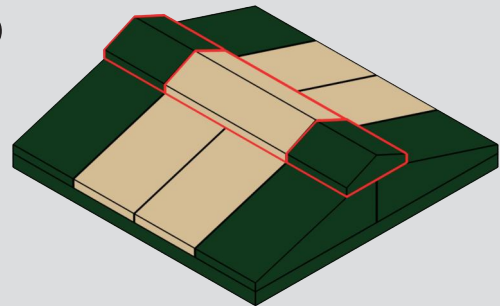

89





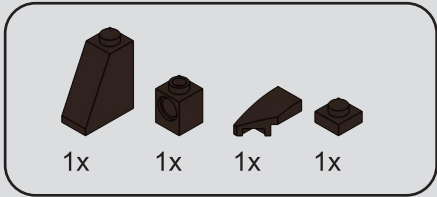

90

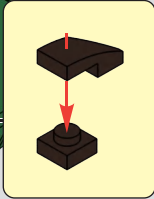
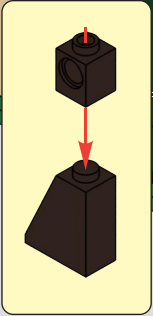
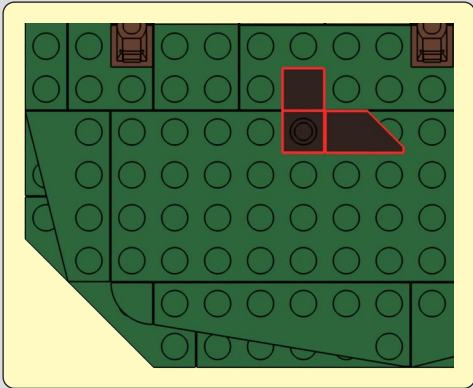

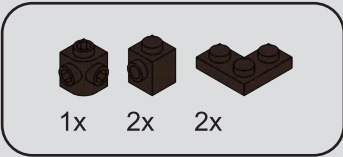

91

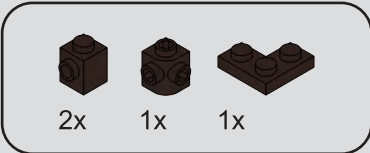
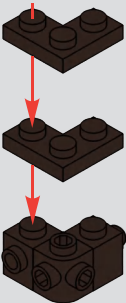

92

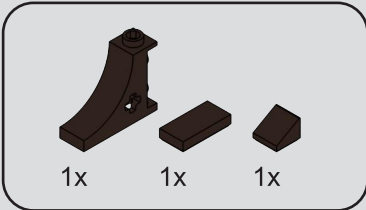
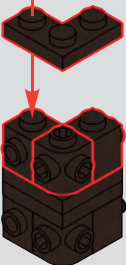

93

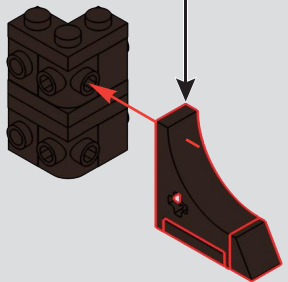
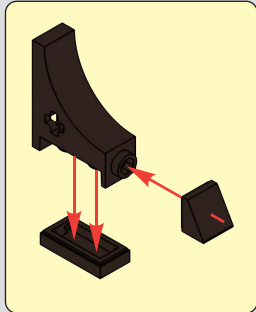

94

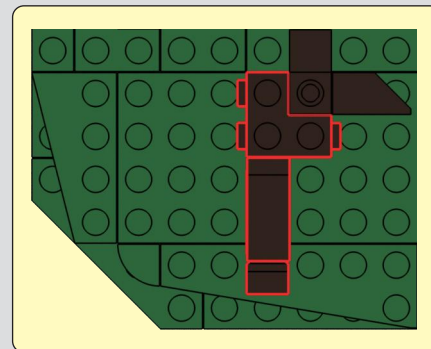

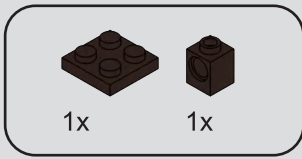

95

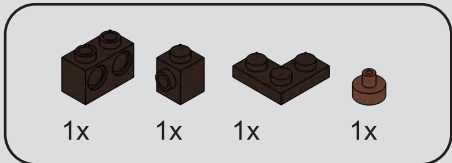
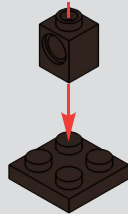

96

1

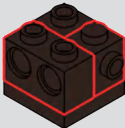

2

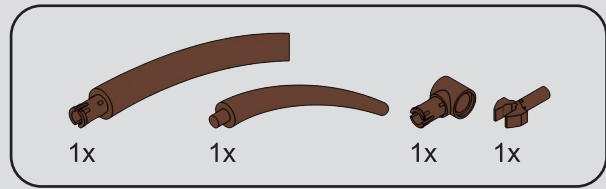
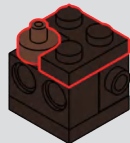

97

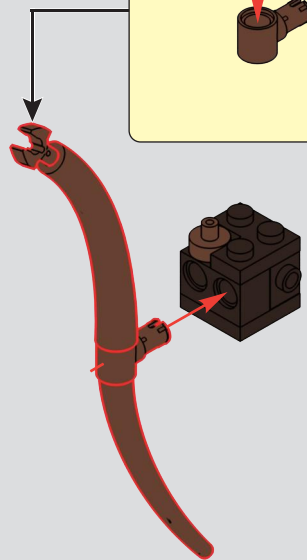
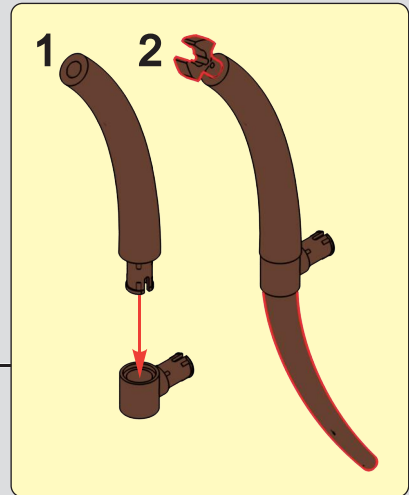

98



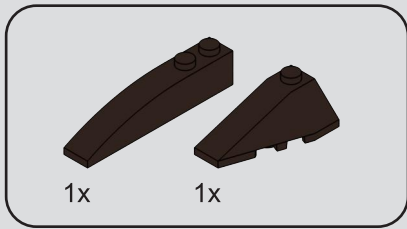

99

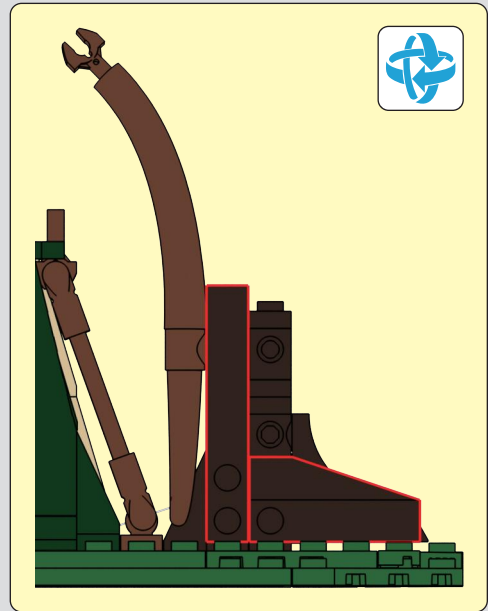

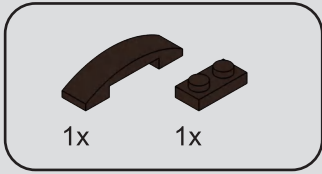

100

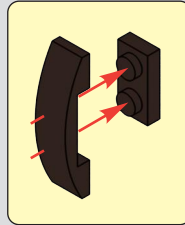

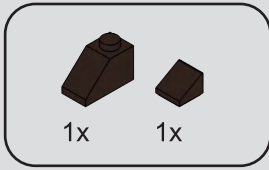

101

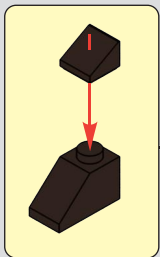

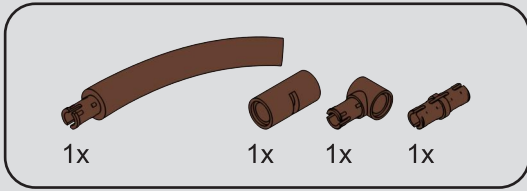

102

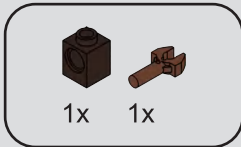
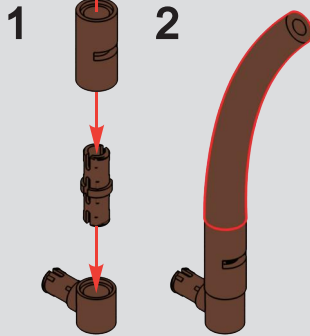

103

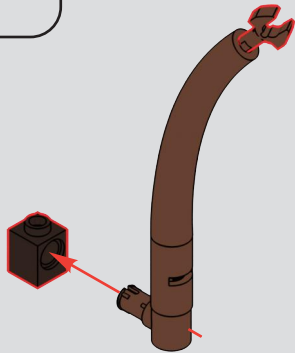

104

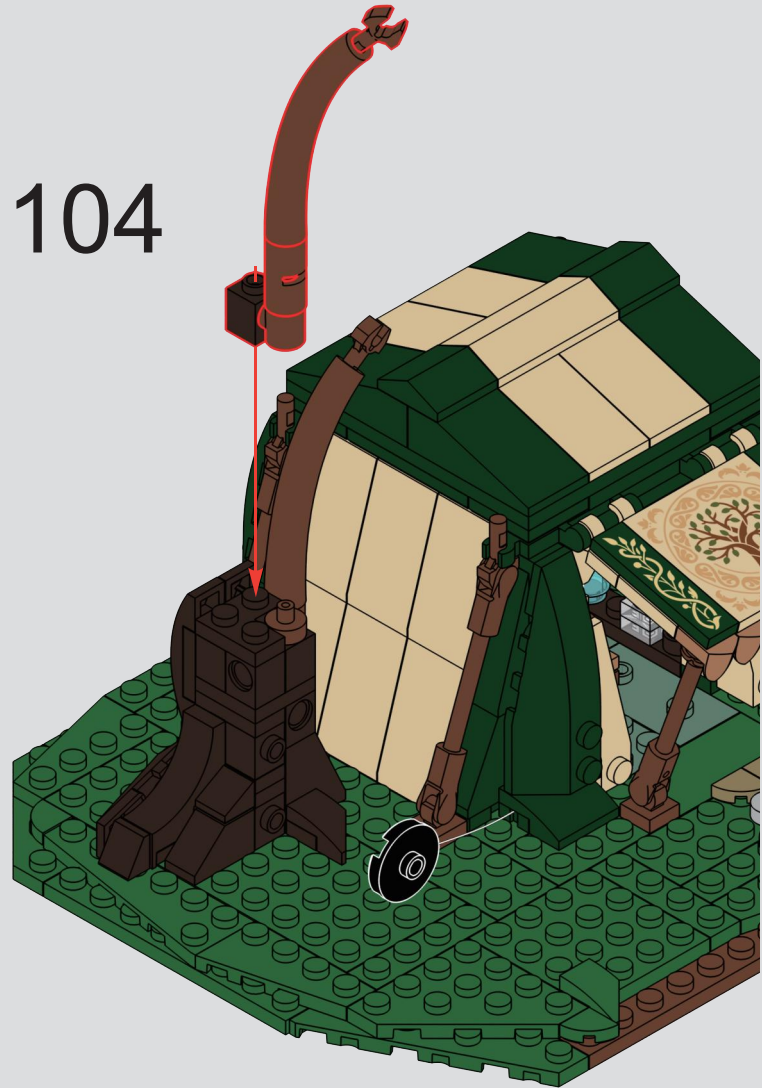

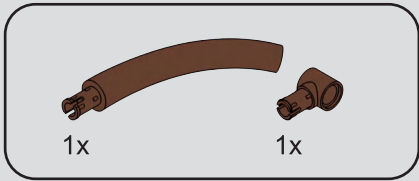

105

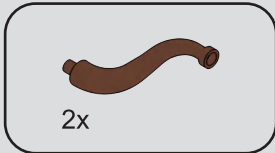
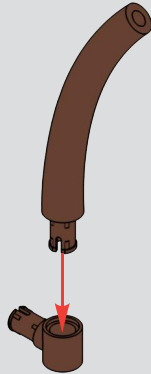

106

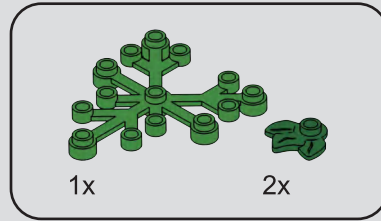
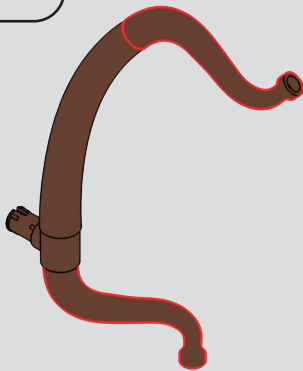

107

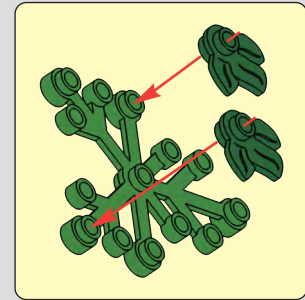

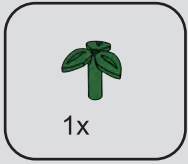

108

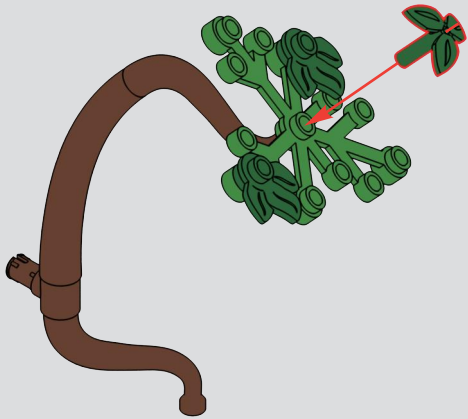

109

1



2



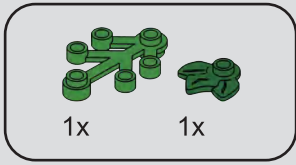

110

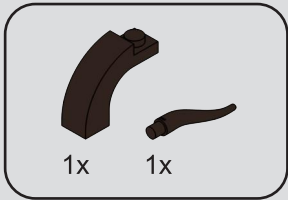
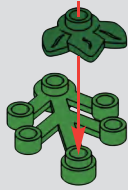

111

1

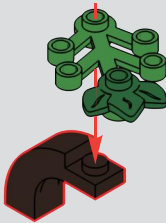

2

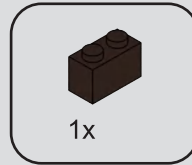
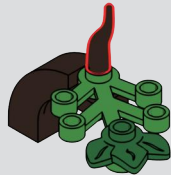

112

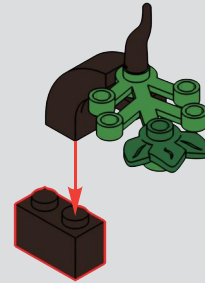

113



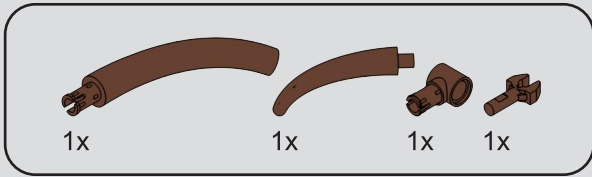

114

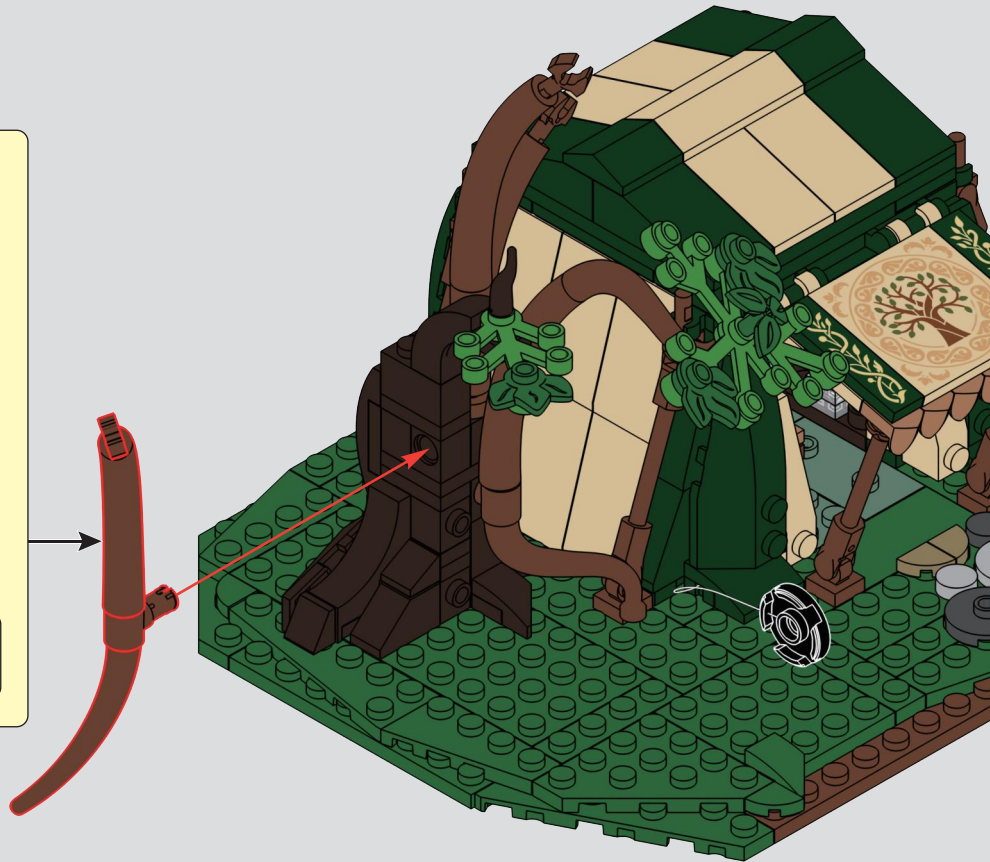
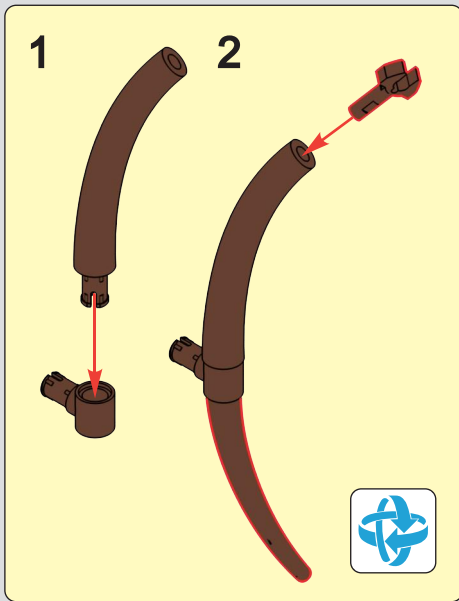

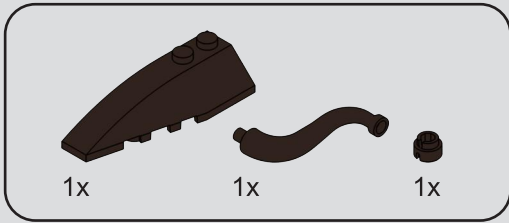

115

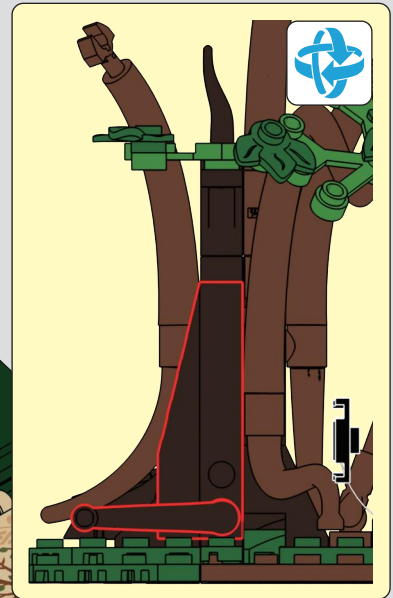
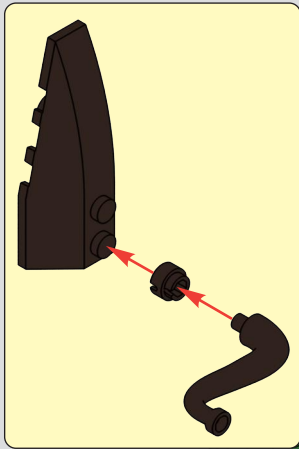

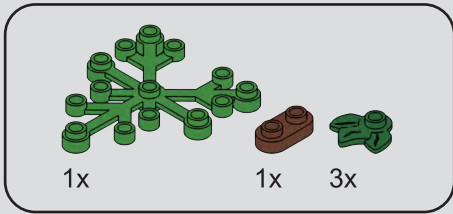

116

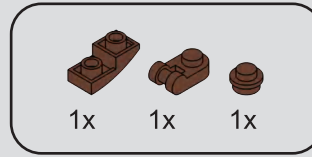
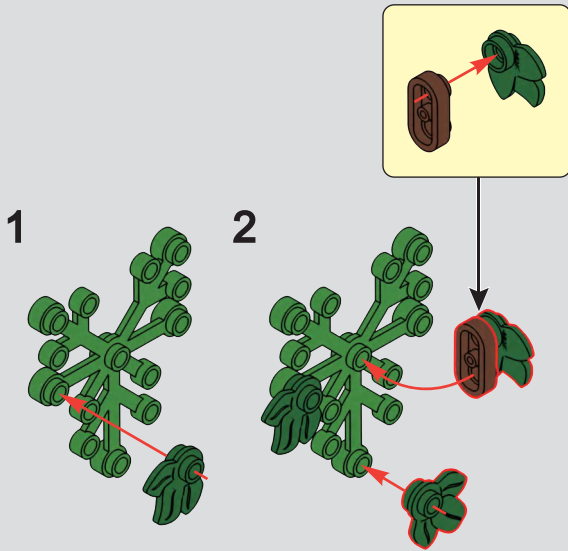

117

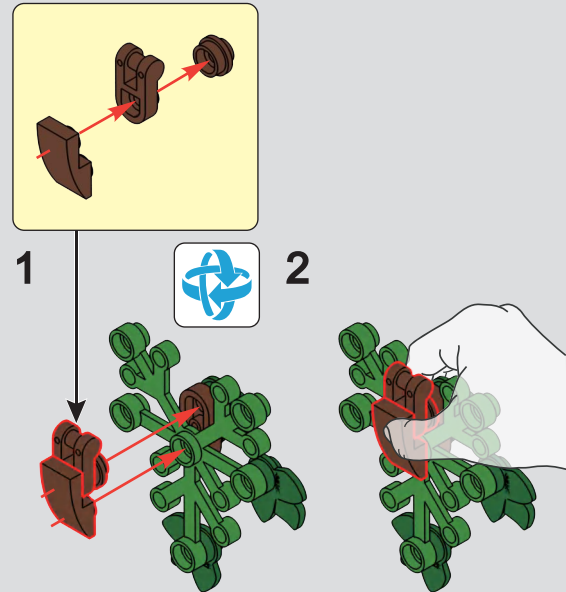

118

1



2



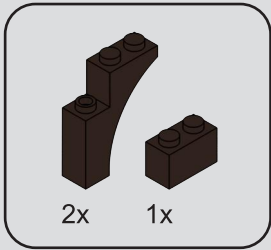

119

1

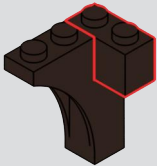

2

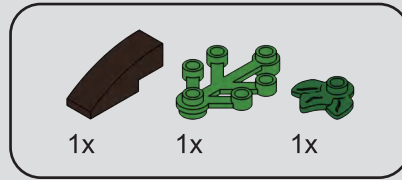
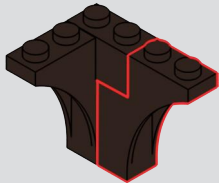

120

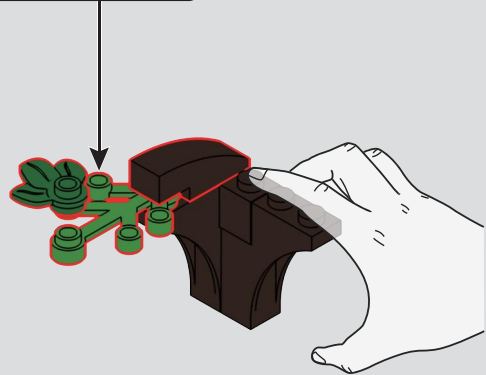
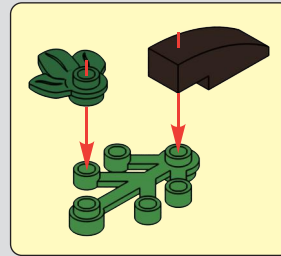

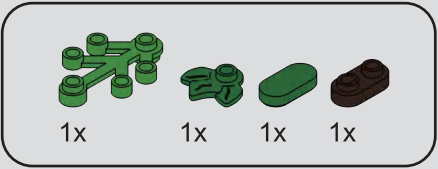

121

1

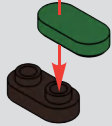

2

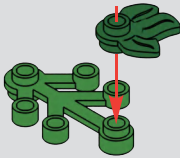

3

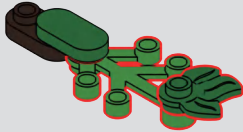

122

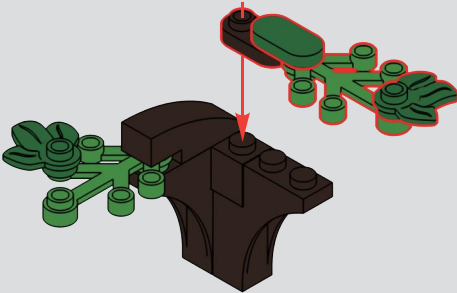

123



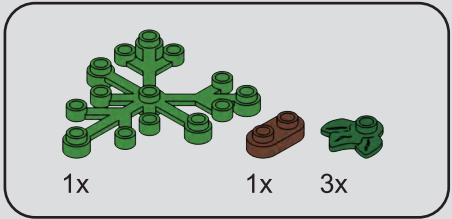

124

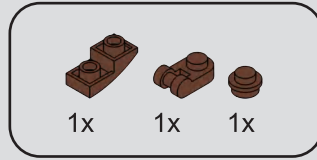
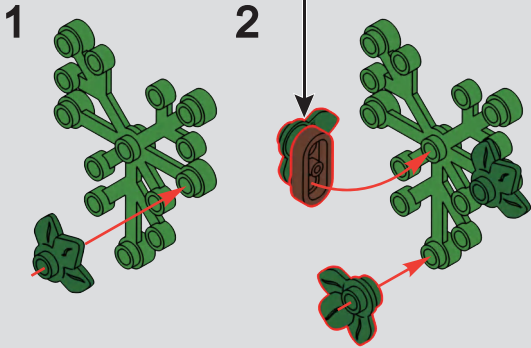
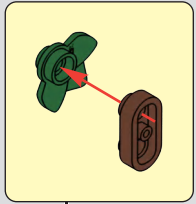

125

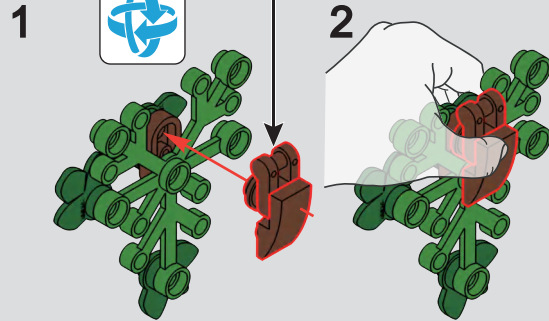
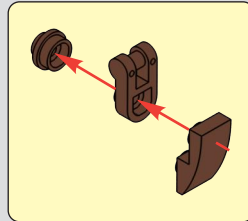

126

1



2



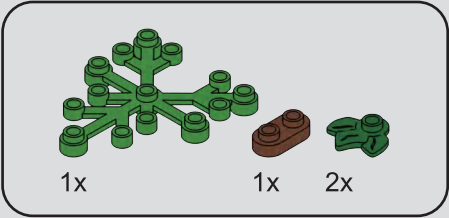

127

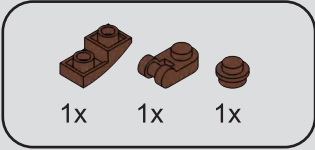
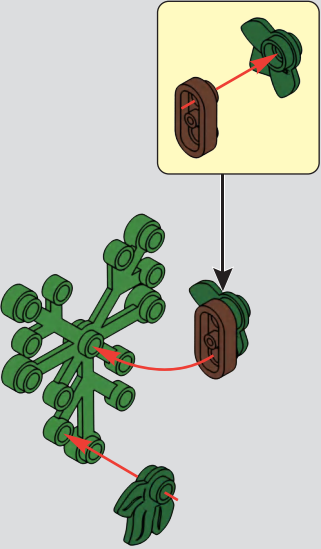

128

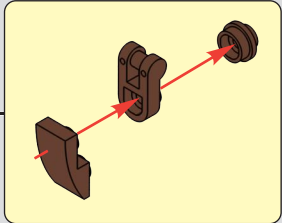

1

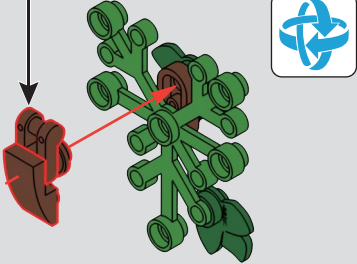

2

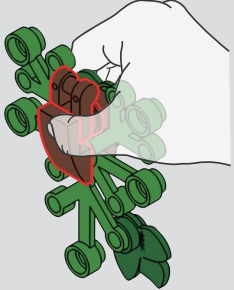

129

1



2



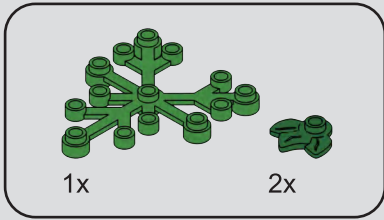

130

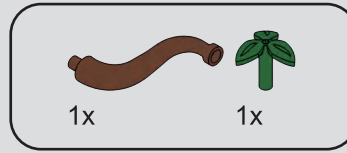
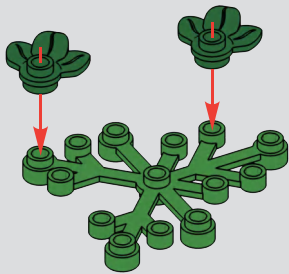

131

1

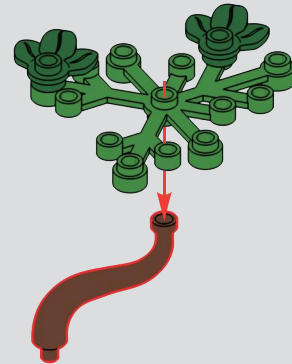

2

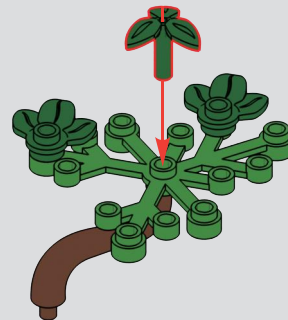

132

1



2



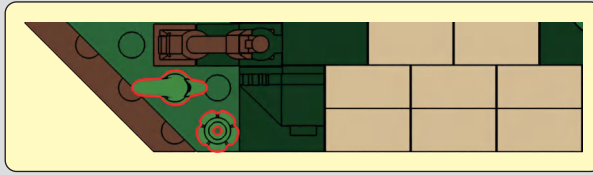
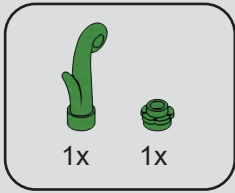

133



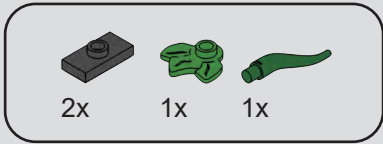

134



1x	1x	2x	2x

135

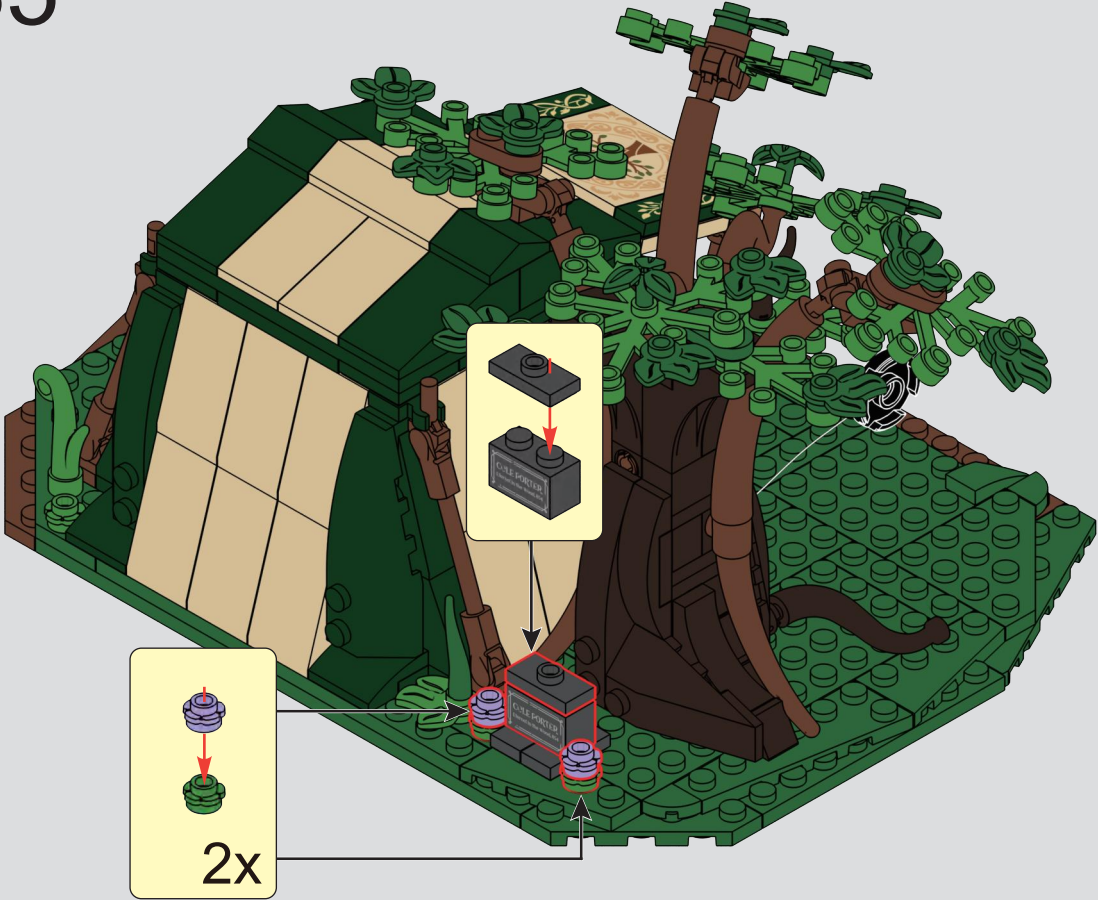



1x

1x

1x

1x

136

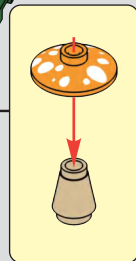
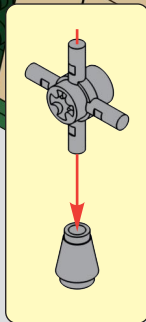

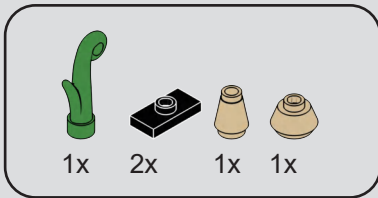

137

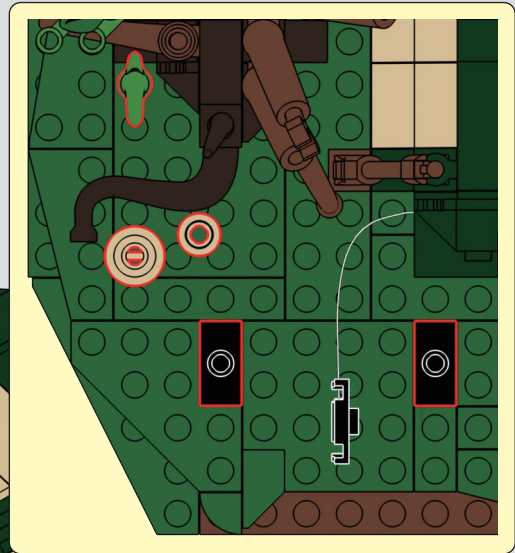

		
1x	1x	1x

138

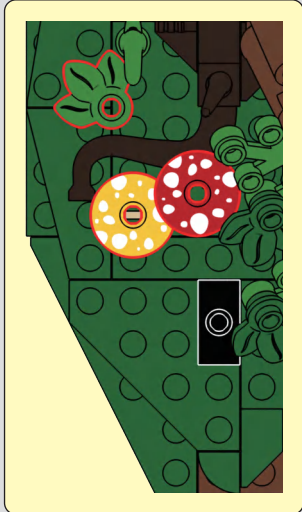

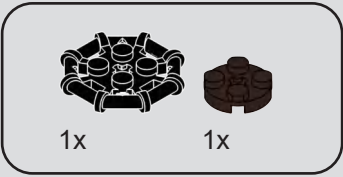

139





140

1

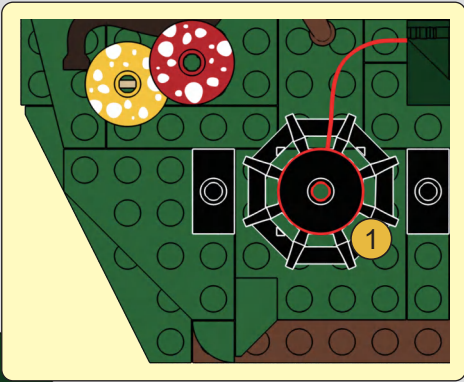

2





141

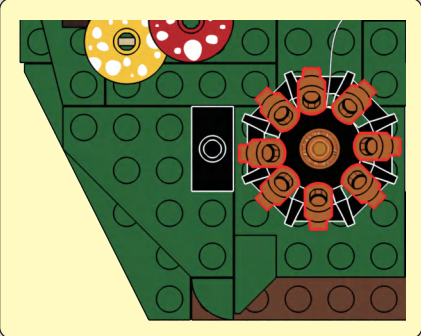

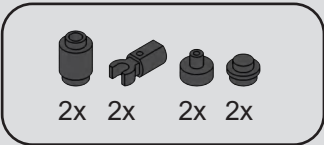

142

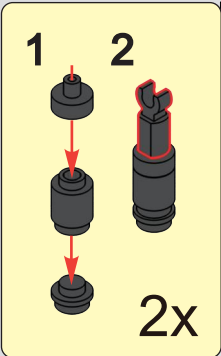
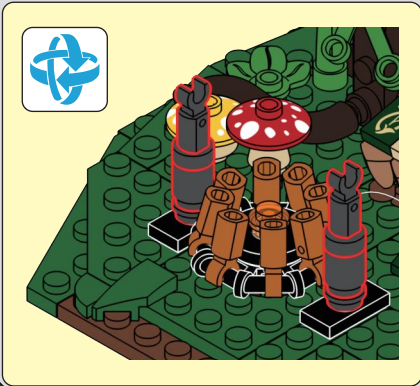

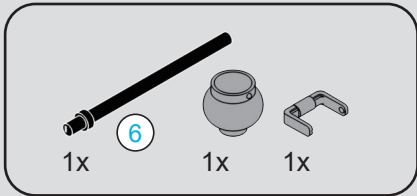

143

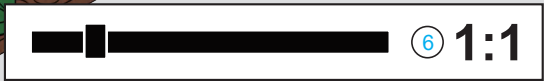
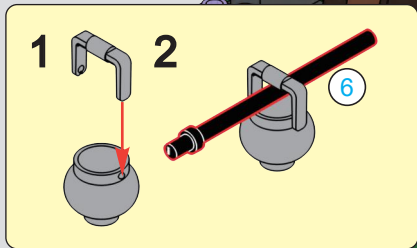
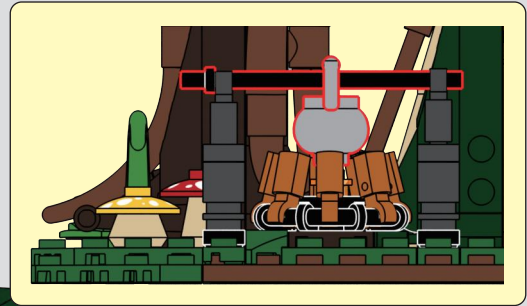

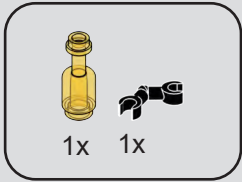

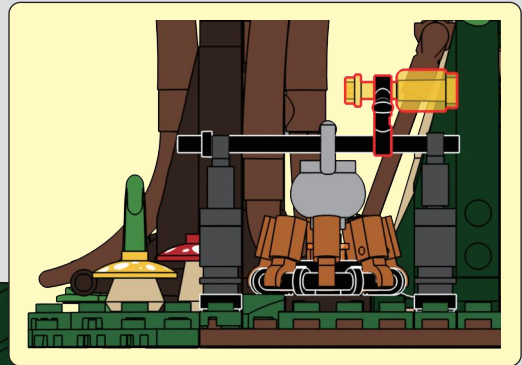

144



1x 1x 1x 1x

145



1x  1x 

146



1x 1x 1x 1x

147





1x



1x



1x



1x



1x



1x

148

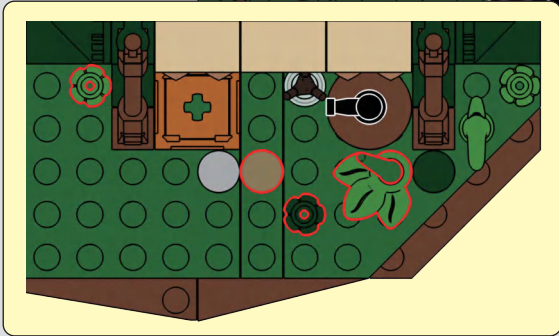
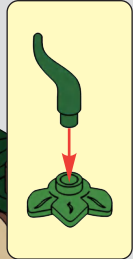

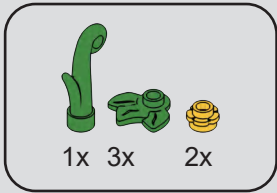

149

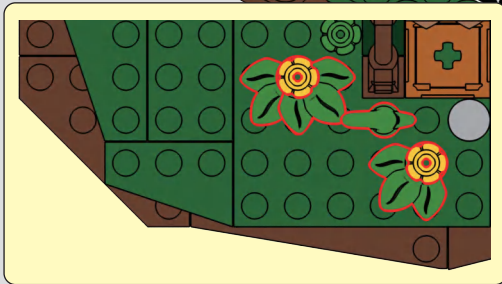

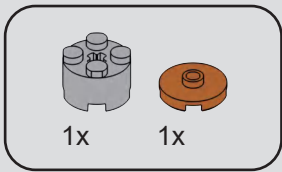

150



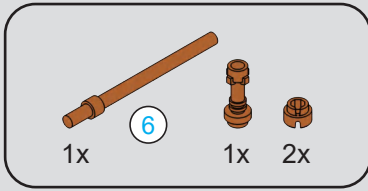

151

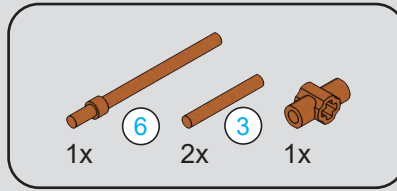
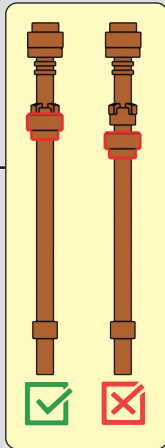
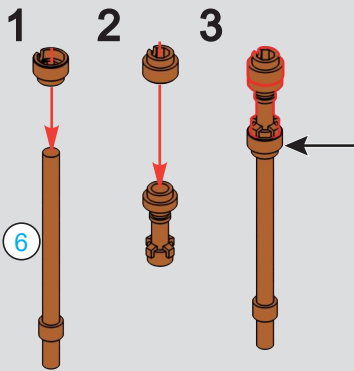

152

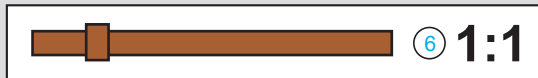
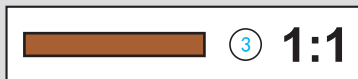
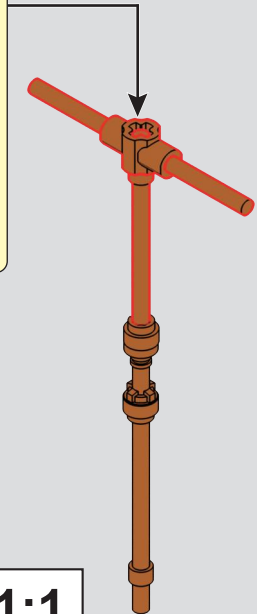
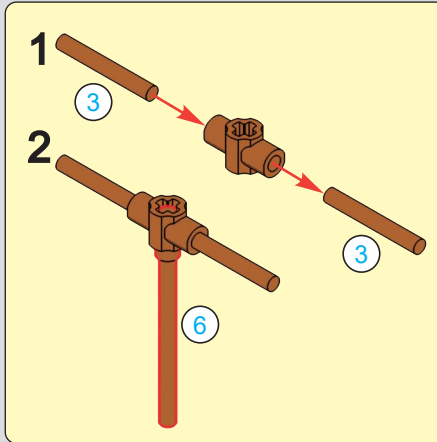

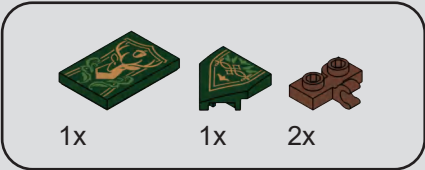

153

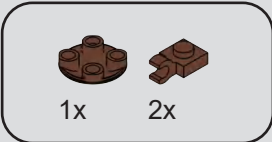
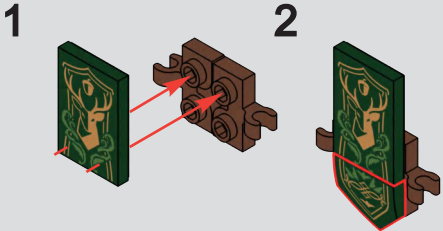

154

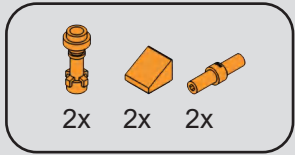
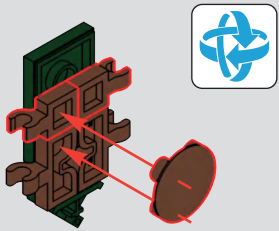

155

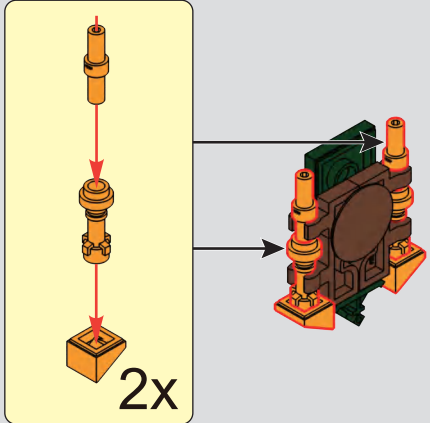
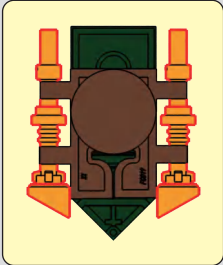



156

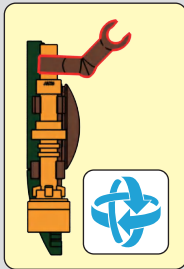
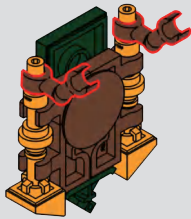

157

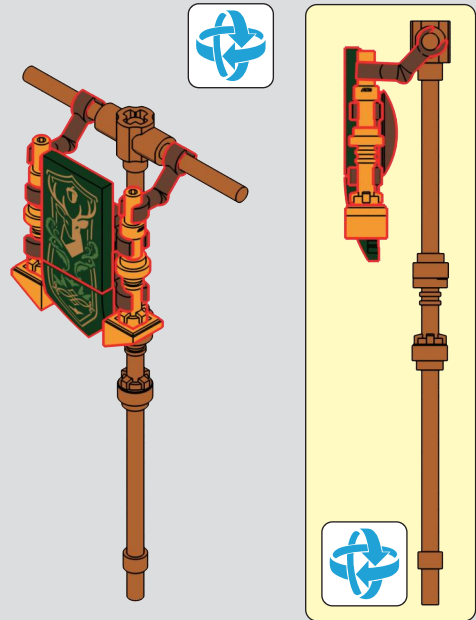

158



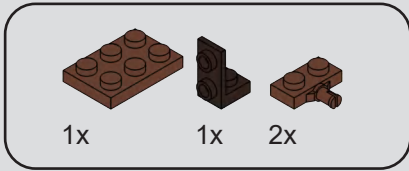

159

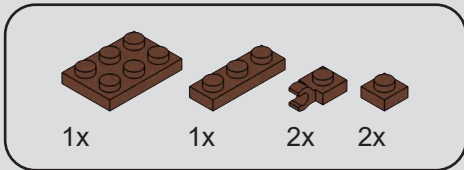
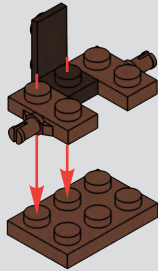

160

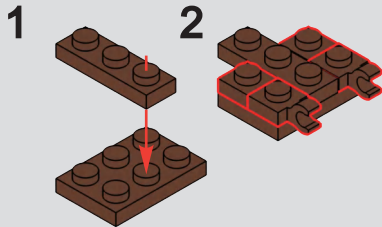

161

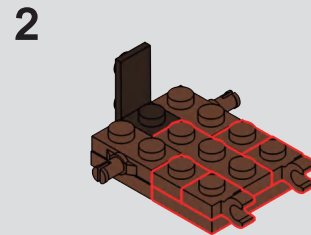
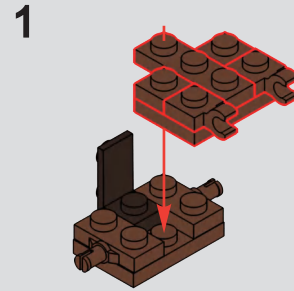

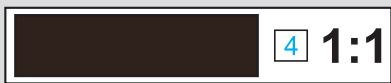
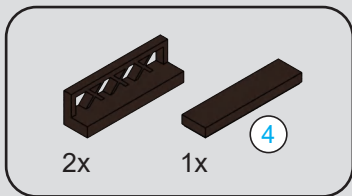

162

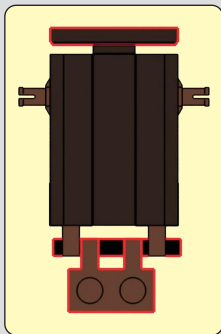
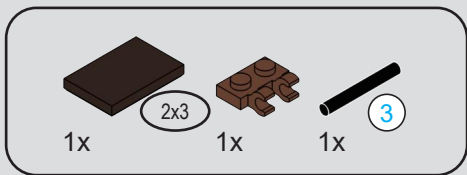
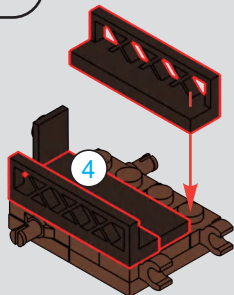

163

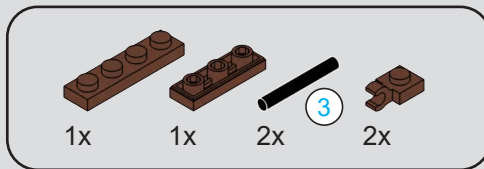
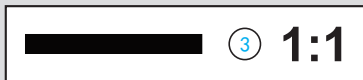
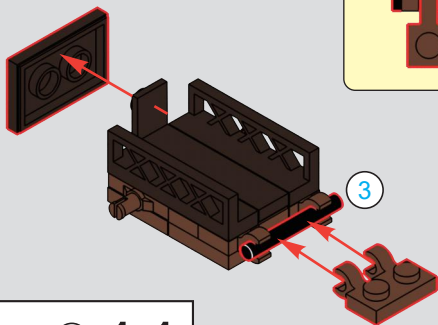

164

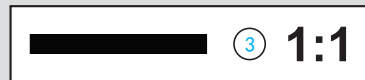
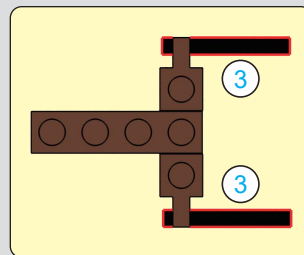
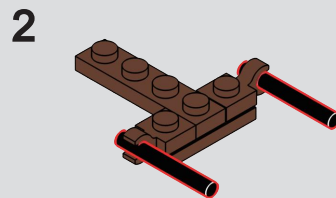
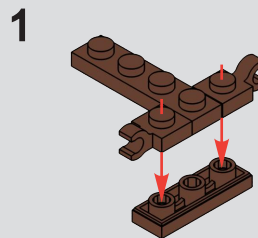

165

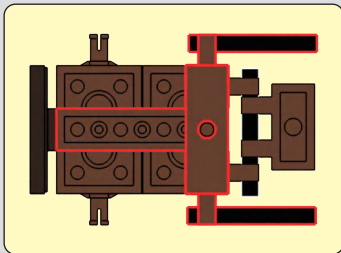
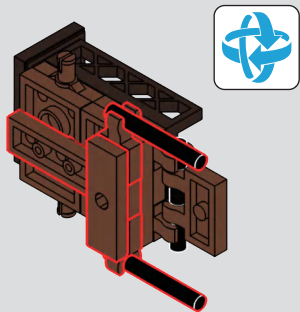

166

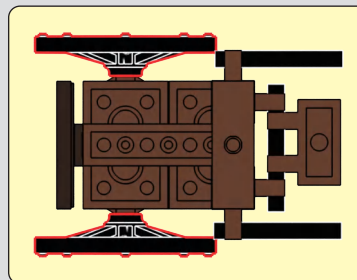
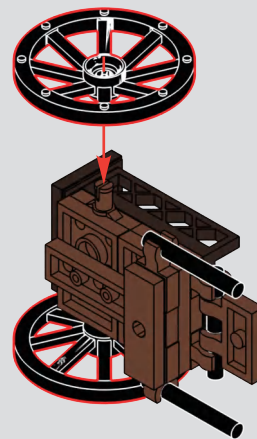

167



168

Play Mode 1

玩法1

1



2



100% OFF ON OFF ON

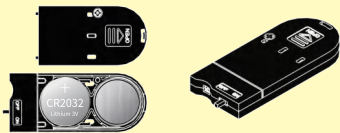

本产品不包含电池

This product does not include batteries

亮灯
LIGHT UP



3



4



169

Play Mode 2

玩法2

1



2



3



170

Play Mode 3

玩法3

1

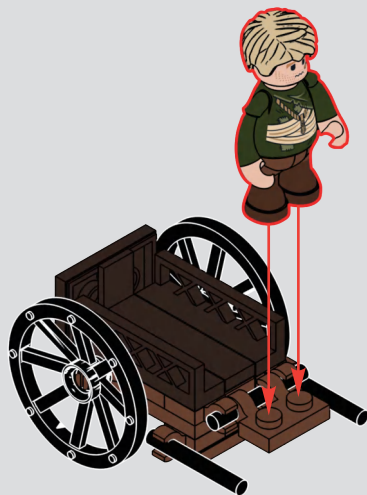

2

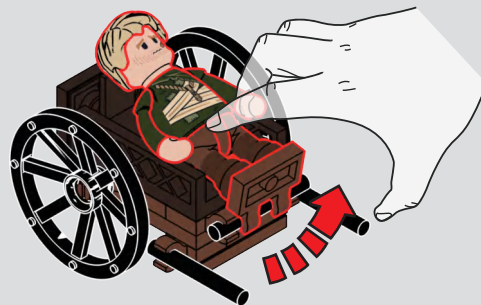

中世纪系列

感谢您对本系列产品的喜爱与支持, 如您在拼搭过程中遇到任何问题, 均可通过微信扫描二维码联系企微客服寻求帮助。如果您还有其他意见或者建议, 也请务必通过企微客服告知我们, 期待与您的再次相遇!



企微客服



MIDDLE AGES

We would like your opinion on the new product you have just purchased. Your feedback will help shape the future development of this product series.

Please visit: <https://www.lumibricks.com/pages/feedback>

We sincerely hope you enjoy the product and we can't wait to see you again soon. Please let us know if we can do anything else to help!

• MIDDLE AGES/中世纪系列



12015
Forest Outpost
森林哨站



12012
King's Castle Treasury
城堡国王宝库



12011
Castle Armory
城堡武器库



12010
Castle Banquet Hall
国王宴会厅

• MIDDLE AGES/中世纪系列



12009
Medieval Troupe Carriage
剧团表演



12008
Water Mill
磨坊



12007
Training Ground
士兵训练场



12006
Forge House
锻造工坊

• MIDDLE AGES/中世纪系列



12005
Medieval Tailor Shop
中世纪裁缝铺



12004
Medieval Watchtower
中世纪瞭望塔



12003
Medieval Apothecary Shop
中世纪药水店



12002
Medieval Market
中世纪集市

• THE OLD WEST/西部系列

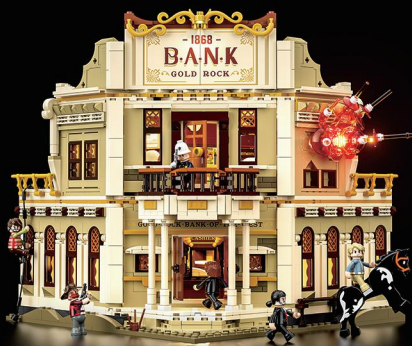

14013
Western Bank Heist
西部银行劫案



14012
Sequoia Bandit Camp
盗贼营地



14011
Old West Blacksmith
西部铁匠铺



14010
Traveling Circus
流浪马戏团

Lumibricks and Lumibricks logo are trademarks of the Lumibricks group.

WWW.LUMIBRICKS.COM 

如果您遇到任何问题, 请通过以下方式与我们联系:



lumibricks灯搭官方旗舰店



会员中心